

Thursday, 29th July, 2018



TECHNICAL DETAILS FOR 'GAF TPO SINGLE-PLY ROOFING SYSTEM', BRANZ.823

Technical Details as listed are available:



- 101 - PARAPET FLASHING
- 102 - PARAPET FLASHING ALTERNATIVE
- 103 - DRIP EDGE ALTERNATIVE
- 104 - DRIP EDGE DETAIL
- 105 - BARGE FLASHING
- 106 - BARGE FLASHING ALTERNATIVE
- 107 - PARAPET TERMINATION BAR
- 108 - BARGE TERMINATION BAR
- 109 - BARGE WRAP DETAIL
- 110 - WELDABLE TPO COATED DRIP EDGE FLASHING
- 201 - CHASE FLASHING ALTERNATIVE
- 202 - CHASE FLASHING
- 203 - WALL TRANSITION
- 204 - SKYLIGHT FLASHING
- 301 - METAL ROOF TRANSITION
- 302 - SHINGLE ROOF TRANSITION
- 303 - METAL ROOF TO TPO
- 304 - SHINGLE ROOF TO TPO
- 305 - TPO - ALUMINIUM JOINERY
- 306 - SUBSTRATE FLASHING JOINT
- 401 - T-JOINT AND JOINT END
- 402 - PREFORMED INSIDE CORNER
- 403 - FOLDED INSIDE CORNER
- 404 - FABRICATED INSIDE CORNER
- 405 - FLUTED OUTSIDE CORNER
- 406 - WALL / CURB OUTSIDE CORNER
- 407 - POST / BALUSTRADE BASE
- 408 - DRESSED BATTEN DETAIL
- 501 - PIPE PENETRATION
- 502 - SPLIT PIPE BOOT
- 503 - HIGH TEMPERATURE STACK
- 504 - POURABLE SEALANT POCKET
- 505 - SQUARE TUBE WRAP
- 506 - DRAIN DROPPER
- 507 - COATED METAL SCRUPPER
- 508 - OVER FLOW PARAPET DRAIN
- 509 - PREMOLDED PIPE BOOT
- 601 - FLOOR JACK PEDESTAL - DECK
- 602 - FLOOR JACK PEDESTAL - TERMINATION
- 603 - FLOOR JACK PEDESTAL - PAVING TILES
- 604 - FLOOR JACK PEDESTAL - DOOR SILL

## **Everguard and Everguard Extreme TPO Roof and Deck Membranes - Technical and Installation Information**

### **Product Description**

Everguard and Everguard Extreme TPO Roof and Deck Membrane Systems are single ply, polyester fabric reinforced, thermoplastic polyolefin (TPO) fully bonded waterproofing sheet membranes for roofs and decks.

## CONSTRUCTION DETAILS FOR 'GAF TPO SINGLE-PLY ROOFING SYSTEM'

**Scope of use**

Everguard and Everguard Extreme TPO Roof and Deck Membrane Systems are for use as roof and deck waterproofing membranes on buildings within the following scope:

- the scope limitations of NZBC Acceptable Solution E2/AS1, Paragraph 1.1; or,
- the scope limitations of NZBC Acceptable Solution E2/AS1, Paragraph 1.1 with respect to building height and maximum floor plan area when subject to specific structural design; and,
- with building structures designed and constructed to meet the requirements of the NZBC; and,
- with substrates of plywood or suspended concrete slabs; and,
- with minimum falls for roofs of 1:30 and decks of 1:40
- with decks that have a maximum area of 40 m<sup>2</sup>; and ,
- situated in NZS 3604 Wind Zones, up to, and including Extra High.

Everguard and Everguard Extreme TPO Roof and Deck Membrane Systems are also for use as roof and deck waterproofing membranes on buildings within the following scope:

- subject to specific structural and weather tightness design; and,
- with substrates of plywood or suspended concrete slab; and,
- situated in specific design wind pressures up to a maximum design differential ultimate limit state (ULS) of 3 kPa; and,
- with the weather tightness design of all junctions for each specific structure being the responsibility of the building designer.

Roofs and decks waterproofed with Everguard and Everguard Extreme TPO Roof and Deck Membrane Systems must be designed and constructed in accordance with the following limitations:

- nominally flat roofs and decks and pitched roofs constructed to drain water to gutters and drainage outlets complying with the NZBC; and,
- with no integral roof gardens; and,
- no steps in level within the deck area, no integral roof gardens and no downpipes direct discharge to decks; and,
- with deck membranes continually protected from physical damage by a pedestrian protection system.



The design and construction of the substrate and movement and control joints is specific to each building, and therefore is the responsibility of the building designer and building contractor.

For technical assistance call 0800 423355  
or visit [www.gafroofing.co.nz](http://www.gafroofing.co.nz)

CONSTRUCTION DETAILS FOR 'GAF TPO SINGLE-PLY ROOFING SYSTEM'

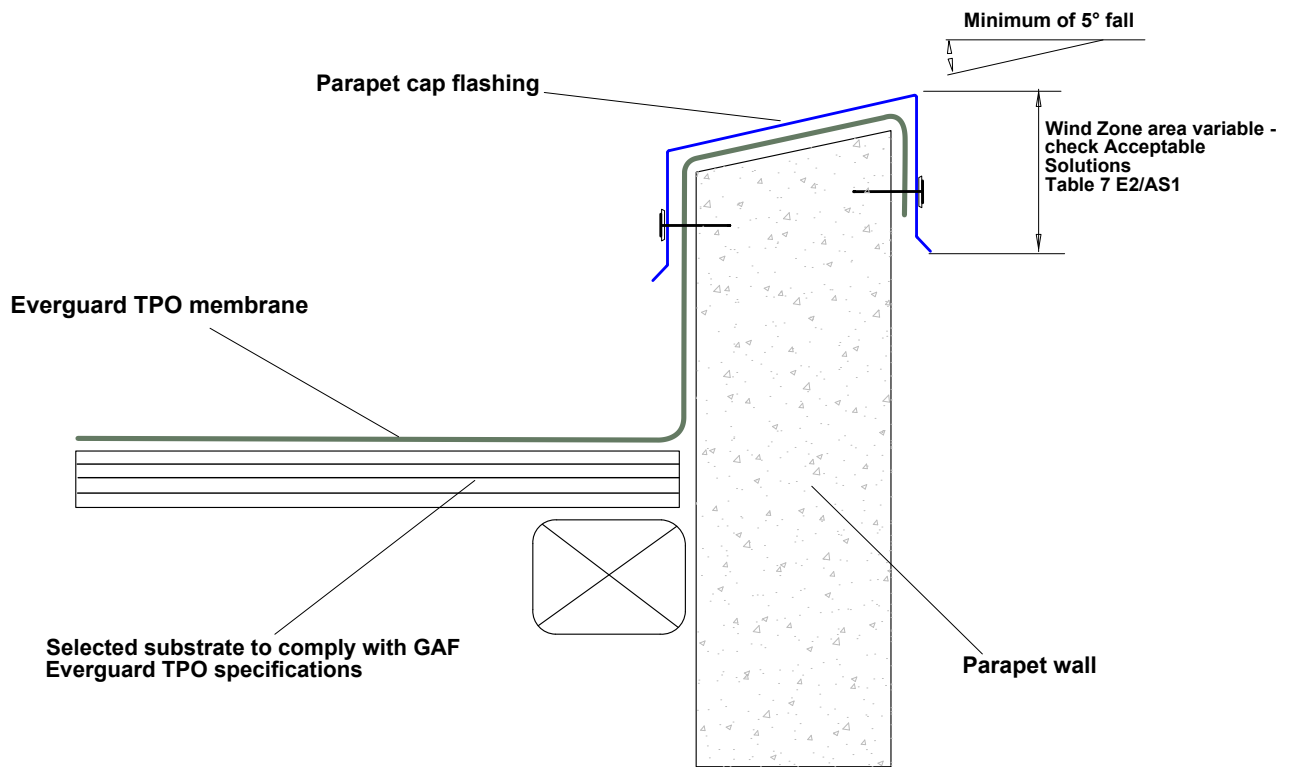

TPO to be laid with adhesive to substrate and parapet prior to installation of parapet cap.



	DRAWING: <b>PARAPET FLASHING</b>	DATE: <b>10 JUNE 2014</b>	DETAIL: <b>101</b>	 BRANZ Appraised Appraisal No 529
	DETAILS FOR: <b>EVERGUARD TPO ROOFING</b>	SCALE: <b>N/A</b>		

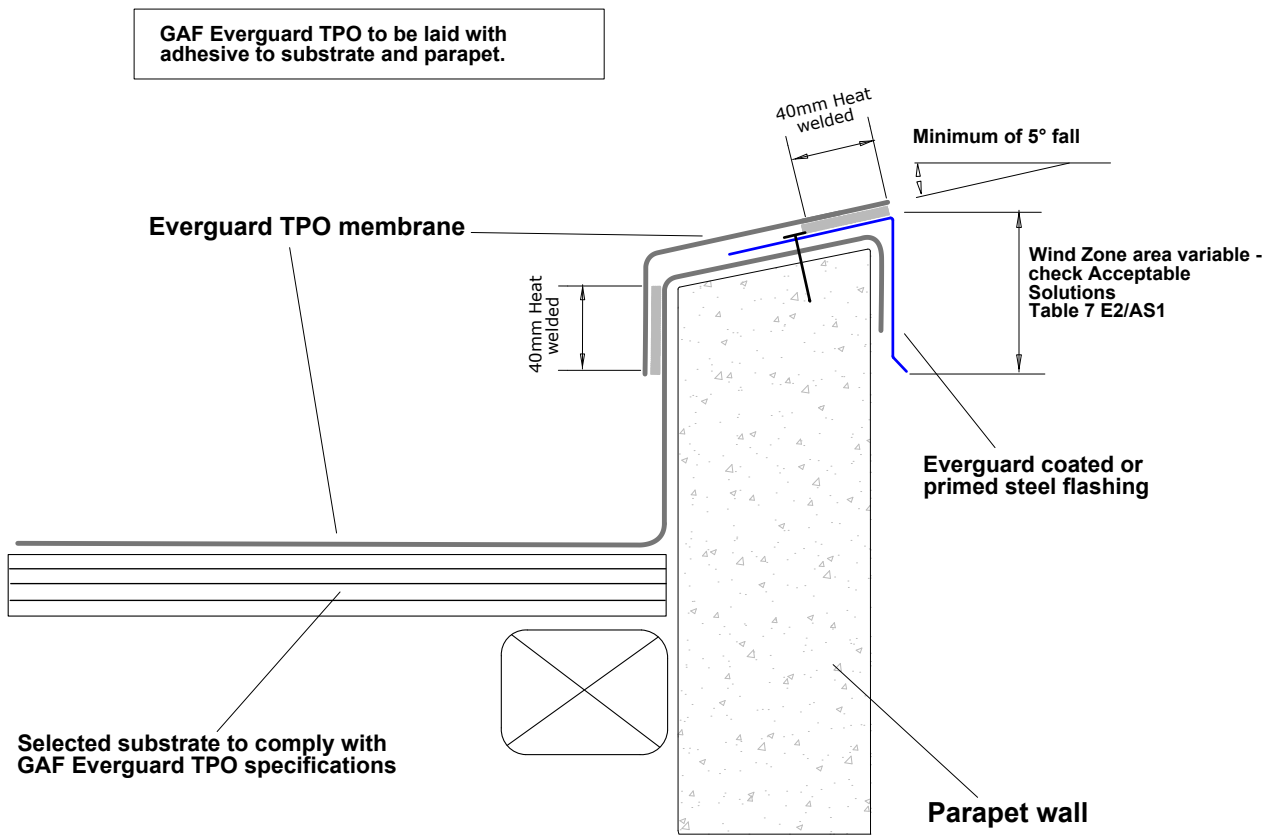

CONSTRUCTION DETAILS FOR 'GAF TPO SINGLE-PLY ROOFING SYSTEM'



	DRAWING: <b>PARAPET WALL ALTERNATIVE</b>	DATE: <b>10 JUNE 2014</b>	DETAIL: <b>102</b>	 BRANZ Appraised Appraisal No 529
	DETAILS FOR: <b>EVERGUARD TPO ROOFING</b>	SCALE: <b>N/A</b>		

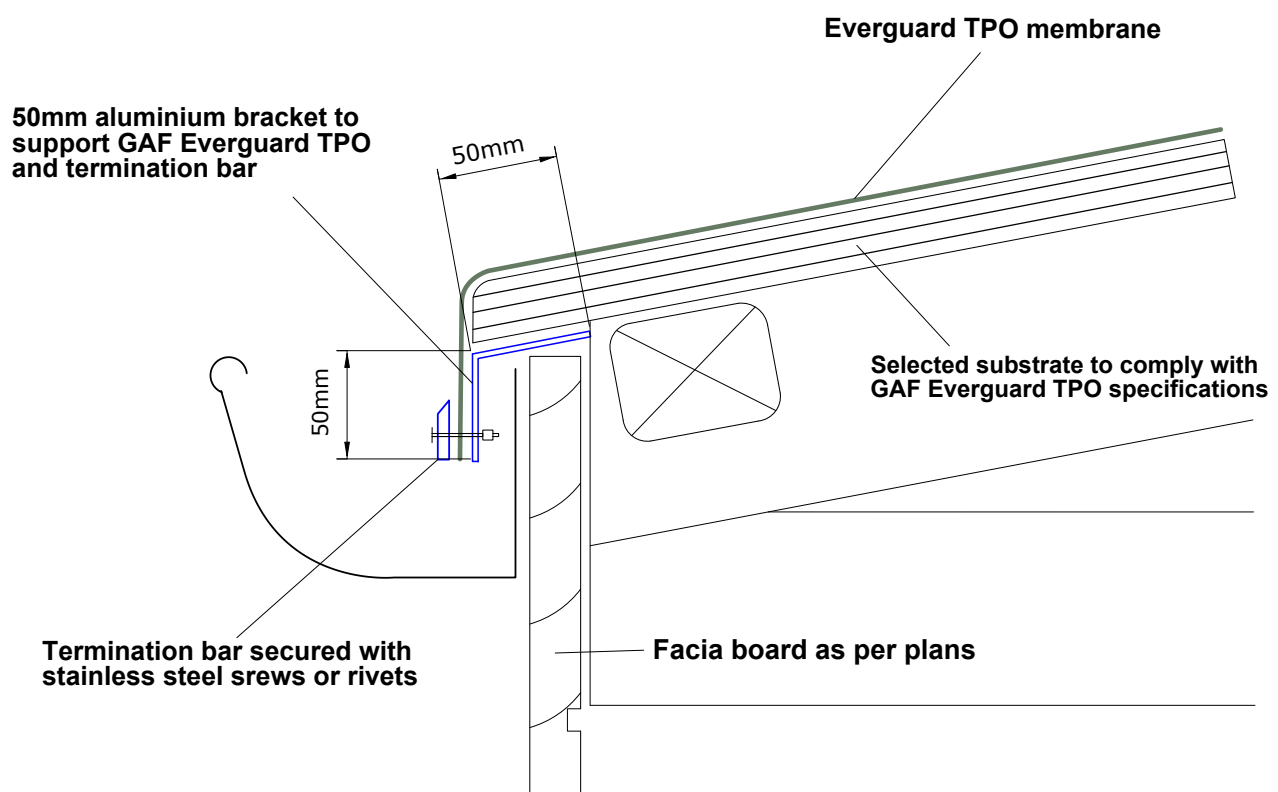

CONSTRUCTION DETAILS FOR 'GAF TPO SINGLE-PLY ROOFING SYSTEM'



	DRAWING: <b>DRIP EDGE ALTERNATIVE</b>	DATE: <b>10 JUNE 2014</b>	DETAIL: <b>103</b>	 BRANZ Appraised Appraisal No 529
	DETAILS FOR: <b>EVERGUARD TPO ROOFING</b>	SCALE: <b>N/A</b>		

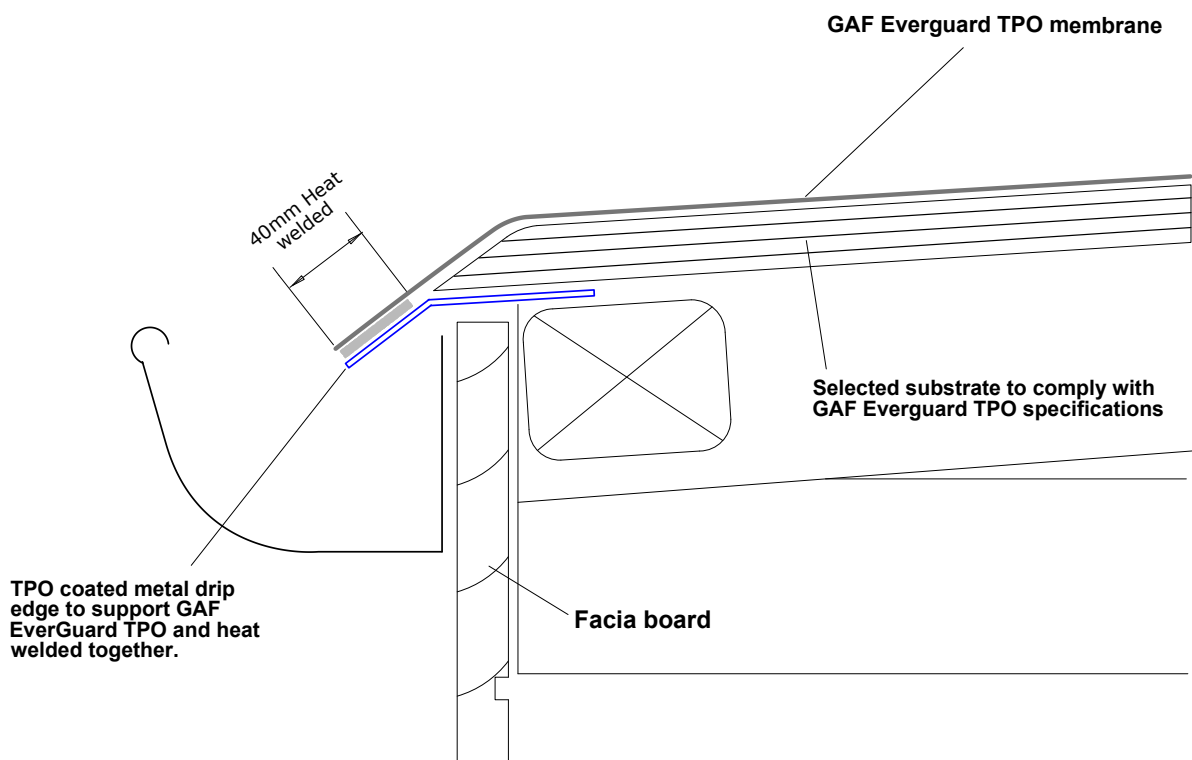

CONSTRUCTION DETAILS FOR 'GAF TPO SINGLE-PLY ROOFING SYSTEM'



	DRAWING: <b>DRIP EDGE SYSTEM</b>	DATE: <b>10 JUNE 2014</b>	DETAIL: <b>104</b>	 BRANZ Appraised Appraisal No 529
	DETAILS FOR: <b>EVERGUARD TPO ROOFING</b>	SCALE: <b>N/A</b>		

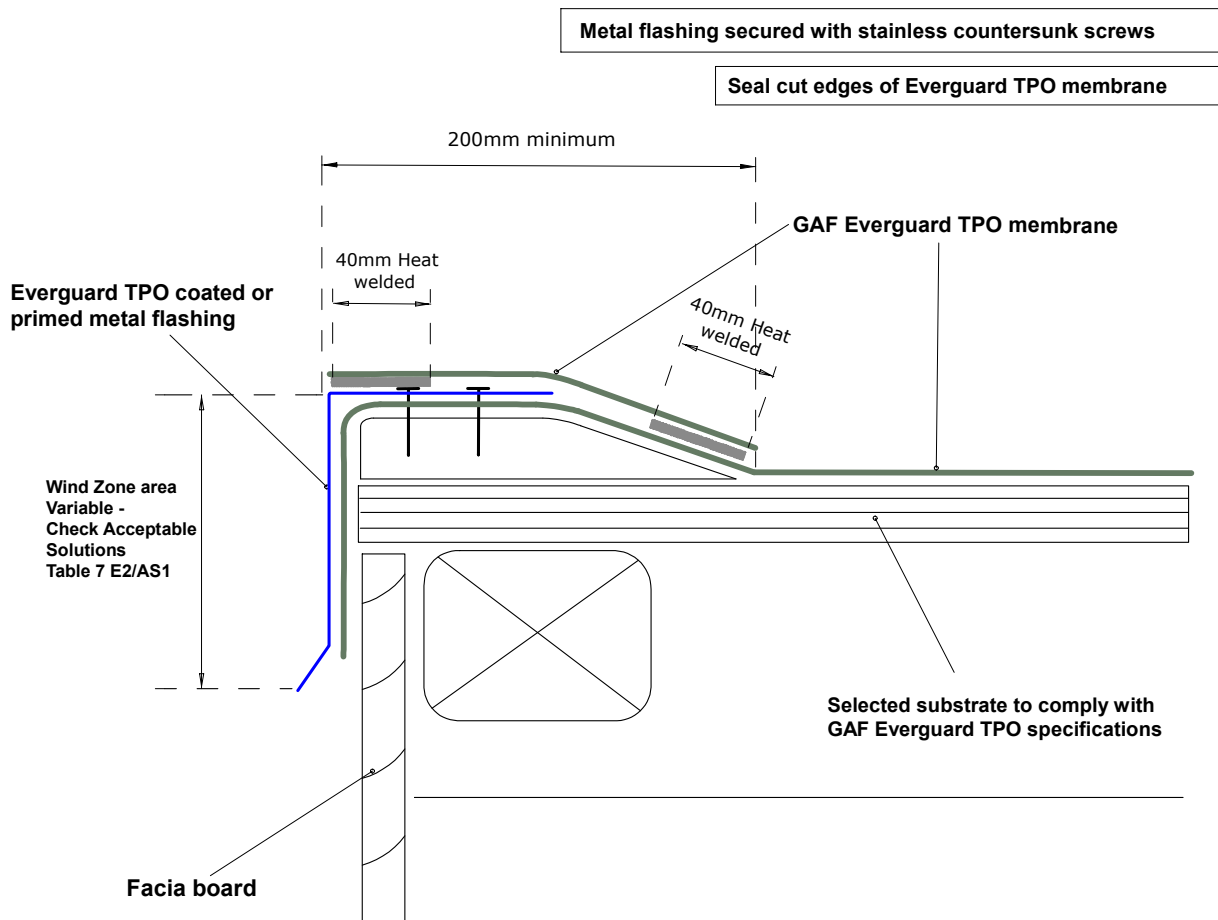

CONSTRUCTION DETAILS FOR 'GAF TPO SINGLE-PLY ROOFING SYSTEM'

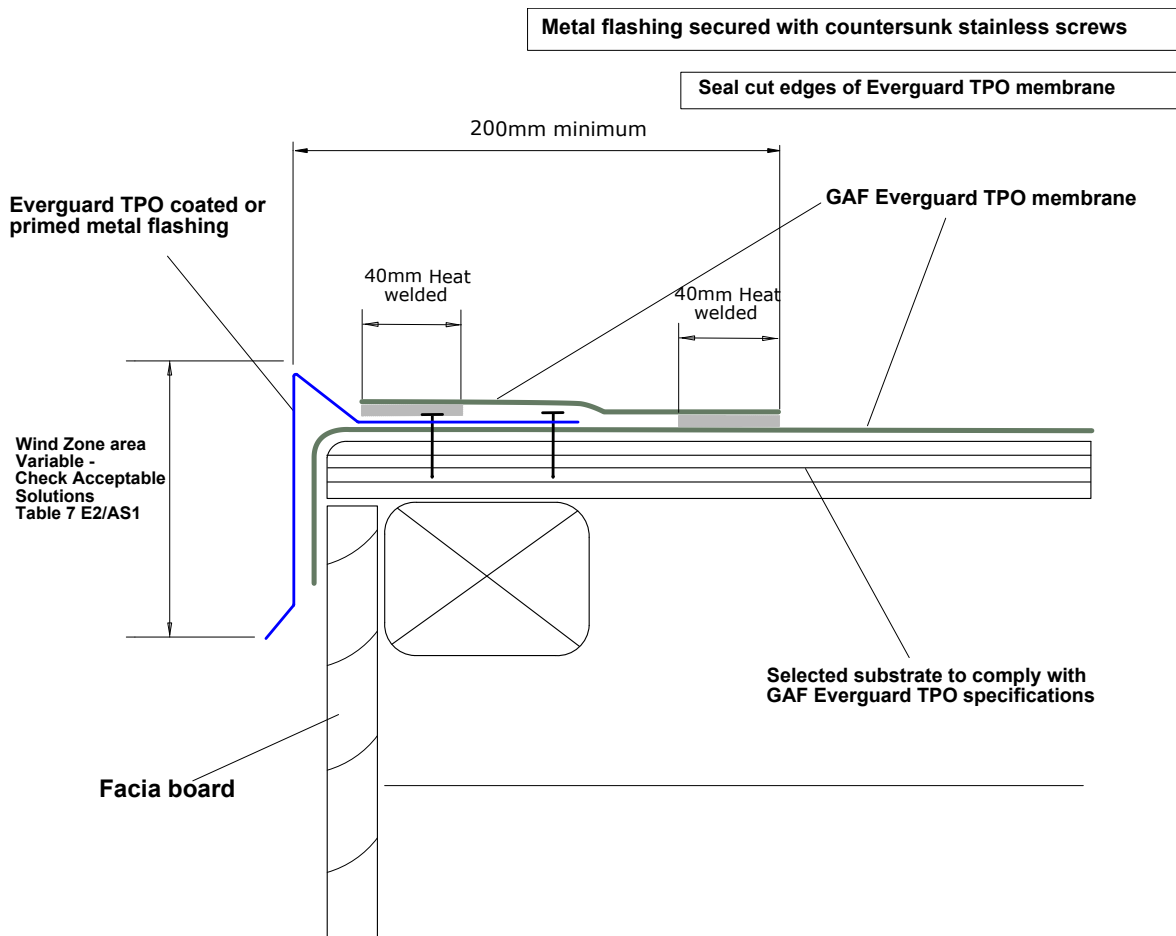

	DRAWING: <b>BARGE FLASHING SYSTEM</b>	DATE: <b>10 JUNE 2014</b>	DETAIL: <b>105</b>	 BRANZ Appraised Appraisal No 529
	DETAILS FOR: <b>EVERGUARD TPO ROOFING</b>	SCALE: <b>N/A</b>		

CONSTRUCTION DETAILS FOR 'GAF TPO SINGLE-PLY ROOFING SYSTEM'





	DRAWING: <b>BARGE FLASHING ALT</b>	DATE: <b>10 JUNE 2014</b>	DETAIL: <b>106</b>	 BRANZ Appraised Appraisal No 529
	DETAILS FOR: <b>EVERGUARD TPO ROOFING</b>	SCALE: <b>N/A</b>		



CONSTRUCTION DETAILS FOR 'GAF TPO SINGLE-PLY ROOFING SYSTEM'

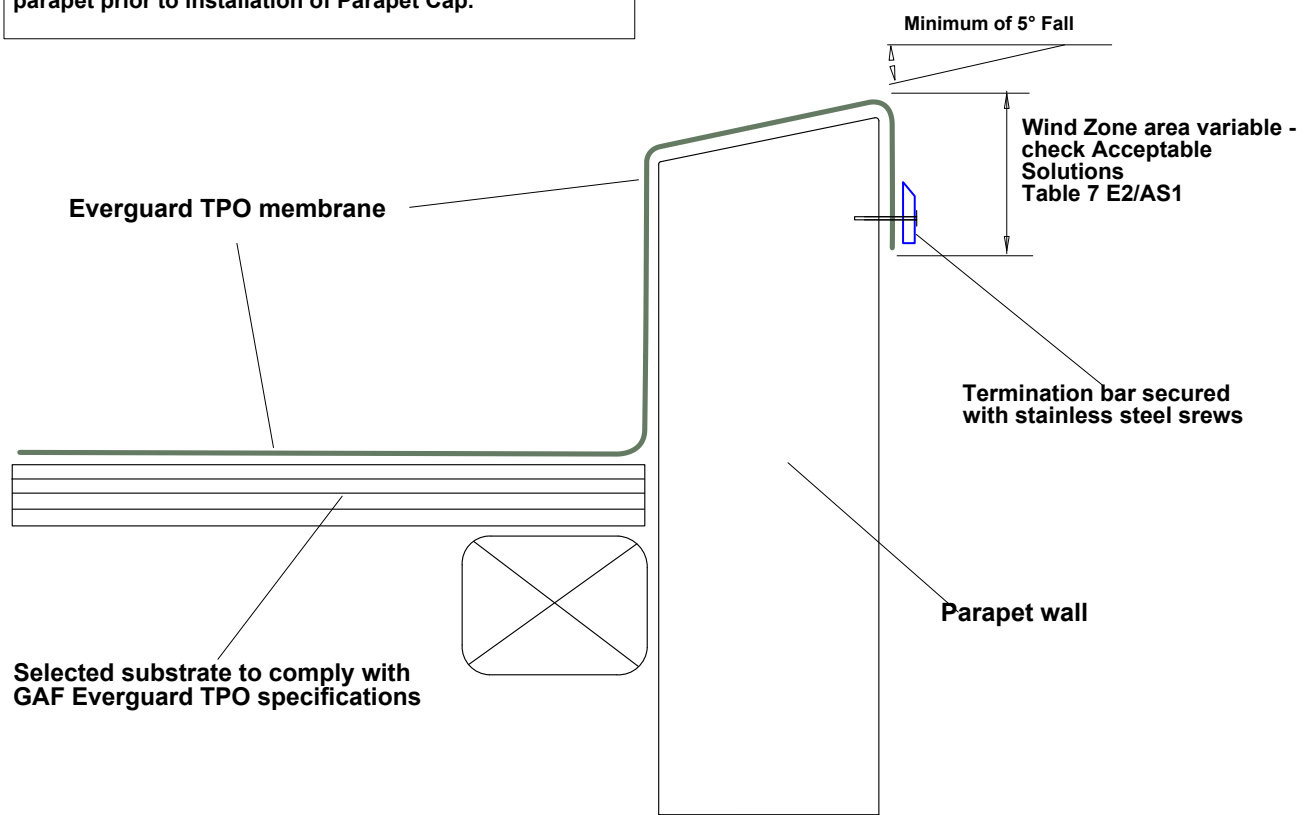

TPO to be laid with adhesive to substrate and parapet prior to installation of Parapet Cap.



	DRAWING: <b>PARAPET TERMINATION BAR</b>	DATE: <b>10 JUNE 2014</b>	DETAIL: <b>107</b>	 BRANZ Appraised Appraisal No 529
	DETAILS FOR: <b>EVERGUARD TPO ROOFING</b>	SCALE: <b>N/A</b>		

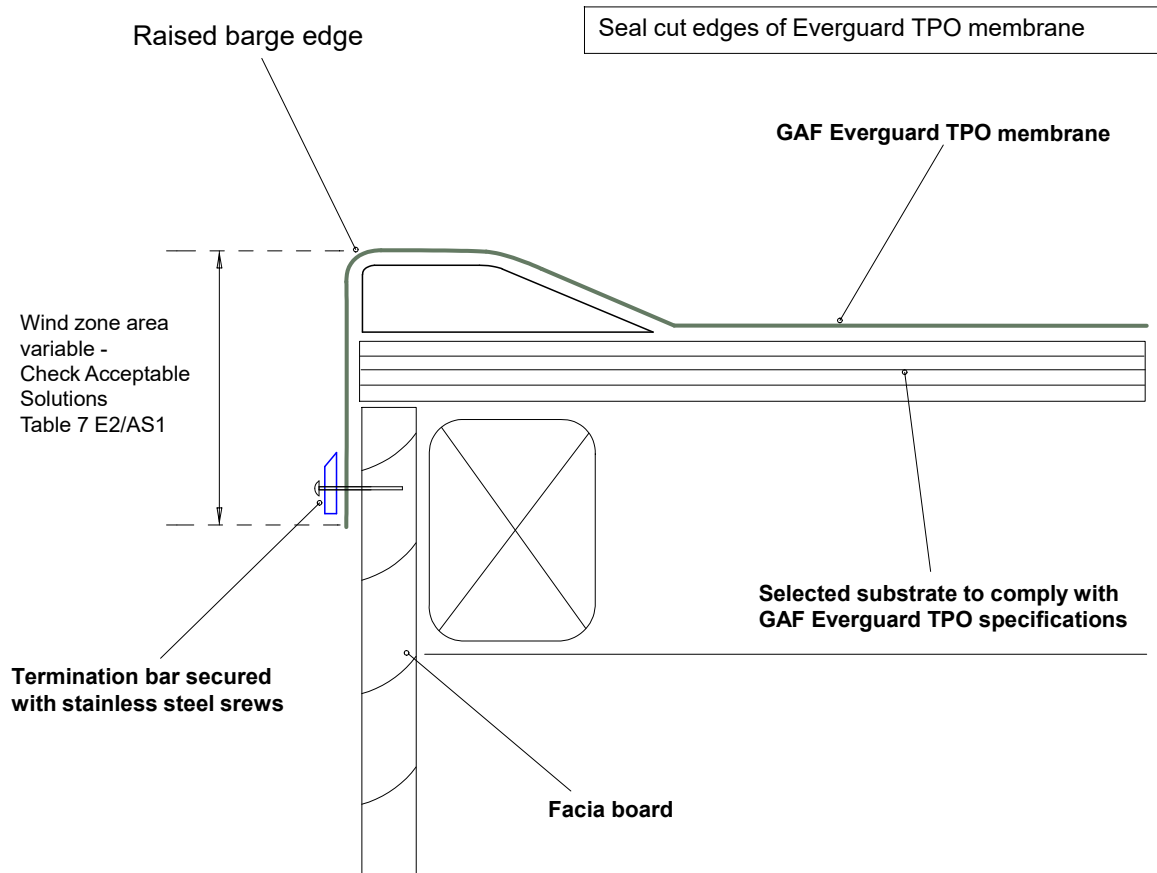

CONSTRUCTION DETAILS FOR 'GAF TPO SINGLE-PLY ROOFING SYSTEM'



	DRAWING: <b>BARGE TERMINATION BAR</b>	DATE: 10 JUNE 2014	DETAIL: 108	 BRANZ Appraised Appraisal No 529
	DETAILS FOR: <b>EVERGUARD TPO ROOFING</b>	SCALE: N/A		

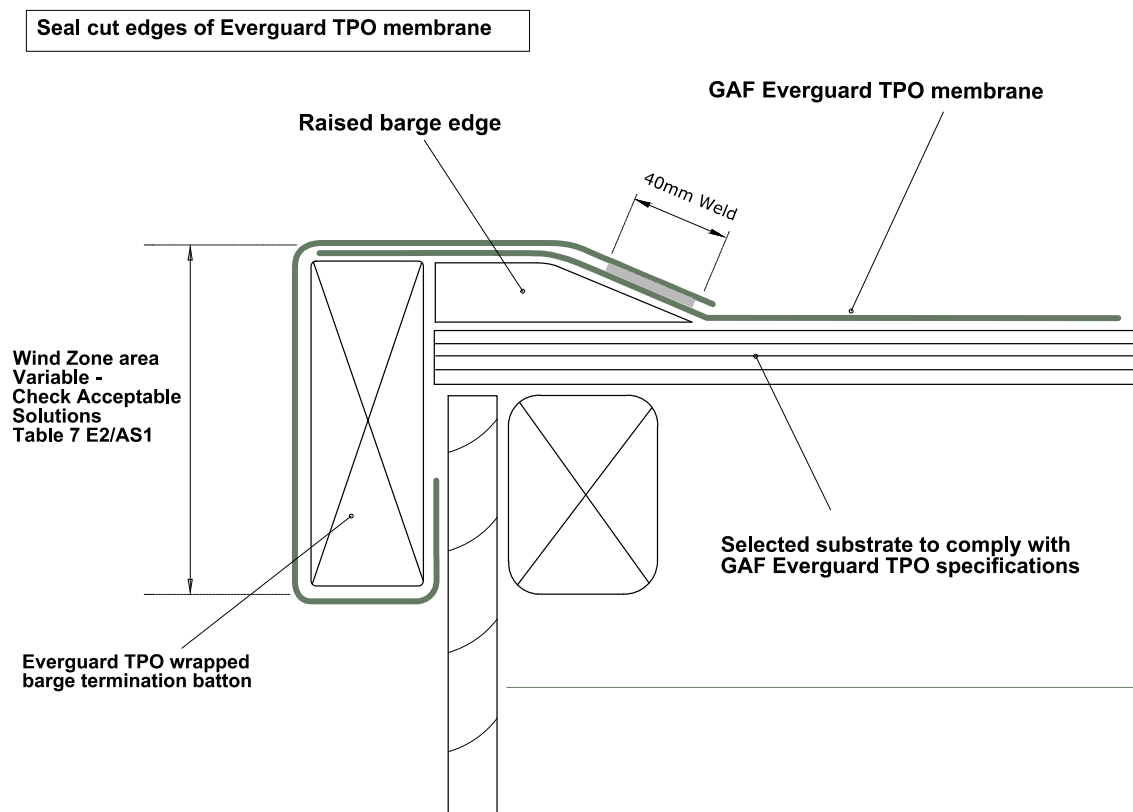

CONSTRUCTION DETAILS FOR 'GAF TPO SINGLE-PLY ROOFING SYSTEM'



	DRAWING: <b>BARGE WRAP DETAIL</b>	DATE: <b>10 JUNE 2014</b>	DETAIL: <b>109</b>	 BRANZ Appraised Appraisal No 529
	DETAILS FOR: <b>EVERGUARD TPO ROOFING</b>	SCALE: <b>N/A</b>		

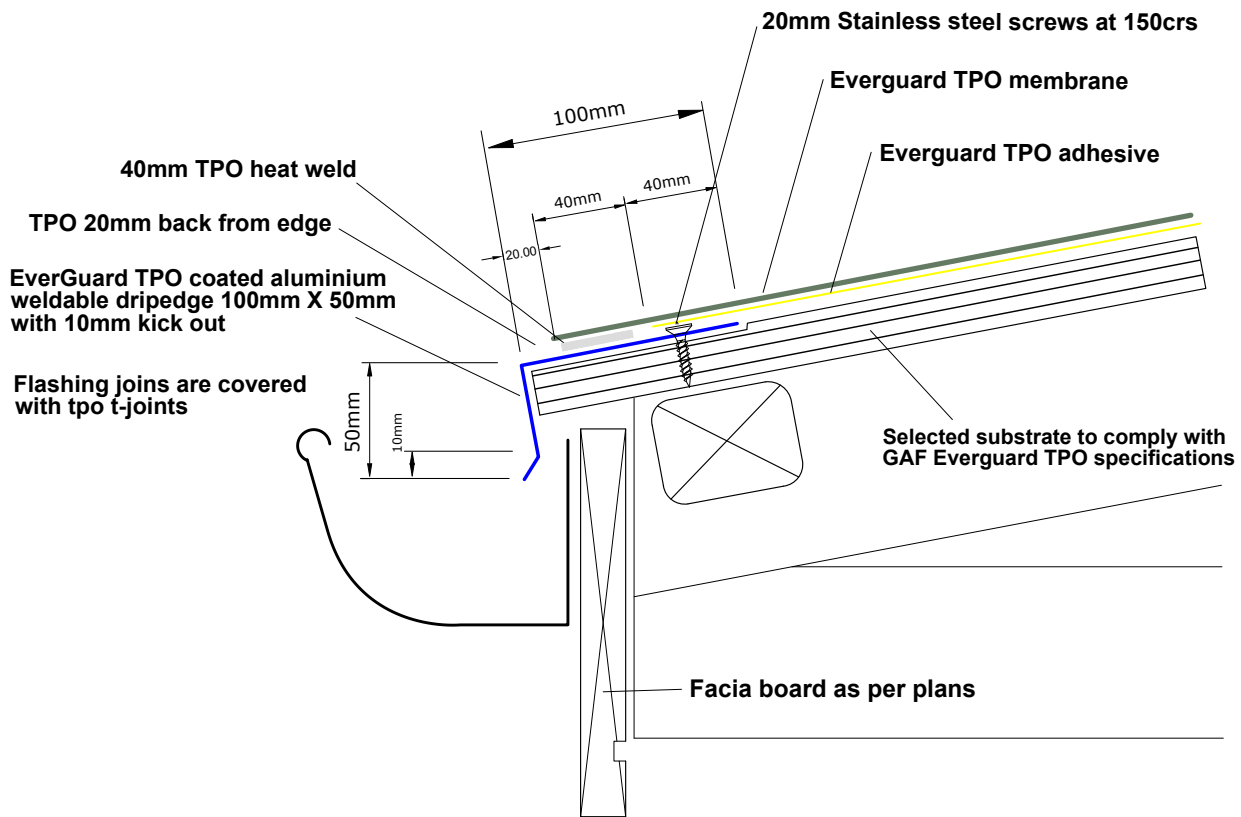

CONSTRUCTION DETAILS FOR 'GAF TPO SINGLE-PLY ROOFING SYSTEM'



	DRAWING: <b>WELDABLE TPO COATED DRIP EDGE FLASHING</b>	DATE: <b>01 MARCH 2019</b>	DETAIL: <b>110</b>	 BRANZ Appraised Appraisal No 529
	DETAILS FOR: <b>EVERGUARD TPO ROOFING</b>	SCALE: <b>NTS</b>		

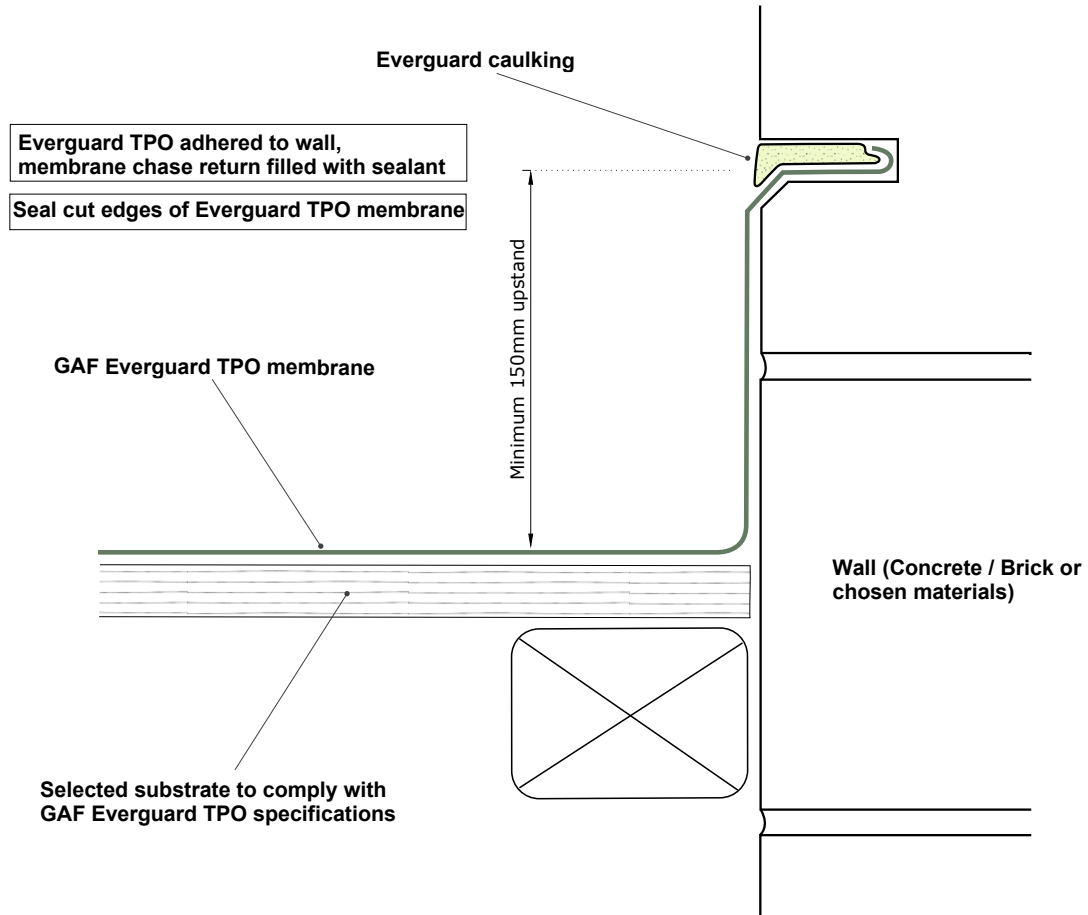

CONSTRUCTION DETAILS FOR 'GAF TPO SINGLE-PLY ROOFING SYSTEM'



	DRAWING: <b>CHASE FLASHING SYSTEM</b>	DATE: <b>10 JUNE 2014</b>	DETAIL: <b>201</b>	 BRANZ Appraised Appraisal No 529
	DETAILS FOR: <b>EVERGUARD TPO ROOFING</b>	SCALE: <b>N/A</b>		

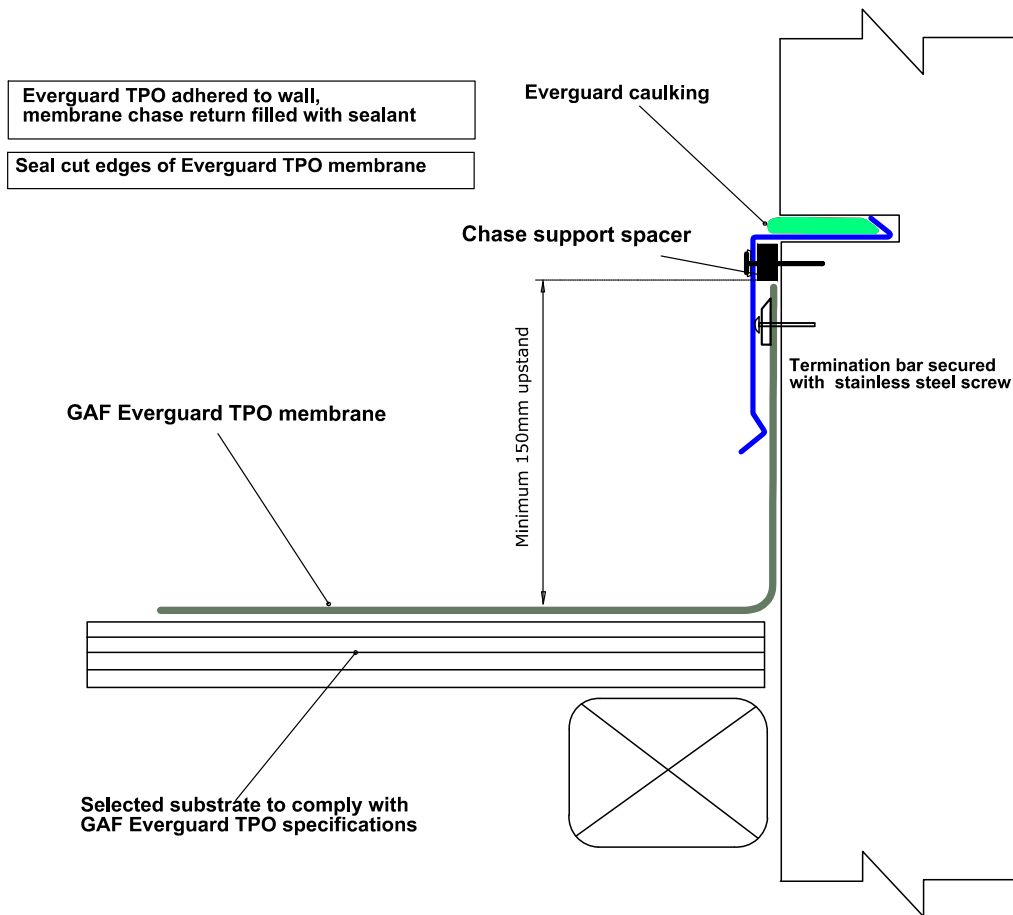

CONSTRUCTION DETAILS FOR 'GAF TPO SINGLE-PLY ROOFING SYSTEM'



	DRAWING: <b>CHASE FLASHING SYSTEM</b>	DATE: <b>10 JUNE 2014</b>	DETAIL: <b>202</b>	 BRANZ Appraised Appraisal No 529
	DETAILS FOR: <b>EVERGUARD TPO ROOFING</b>	SCALE: <b>N/A</b>		

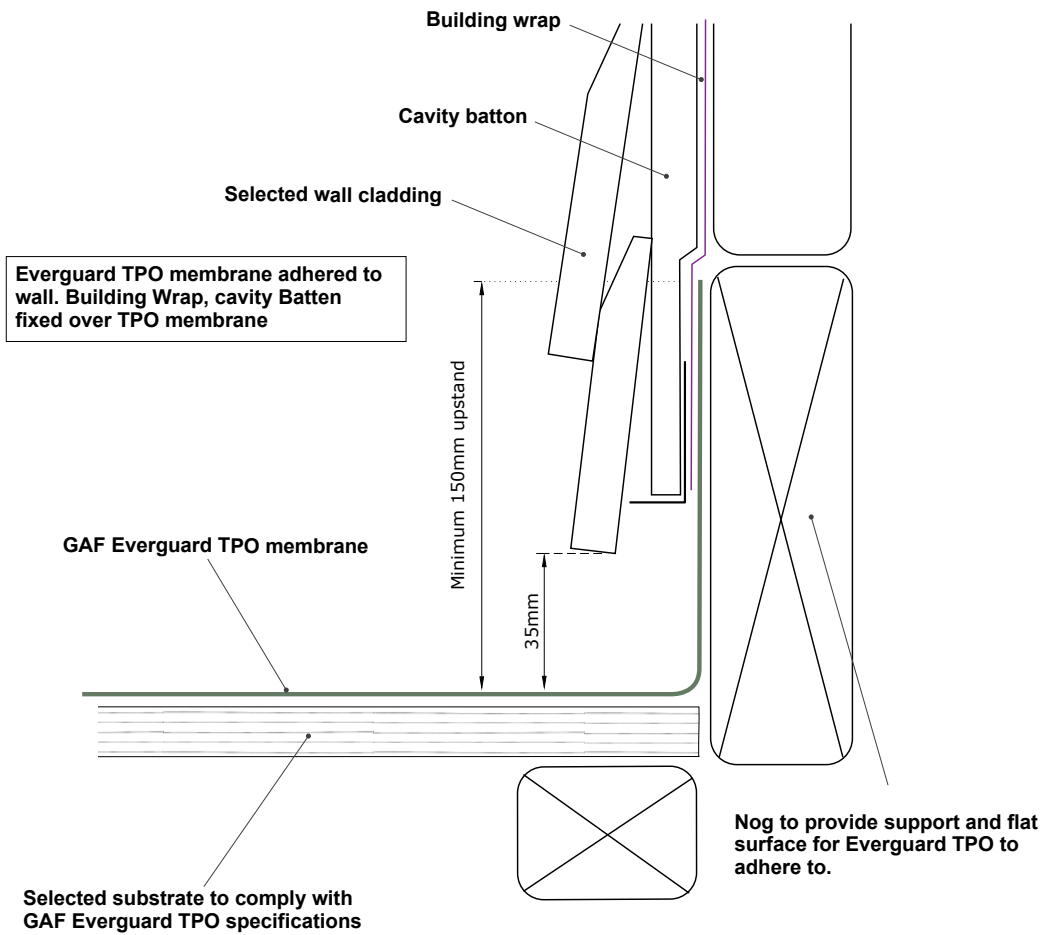

CONSTRUCTION DETAILS FOR 'GAF TPO SINGLE-PLY ROOFING SYSTEM'

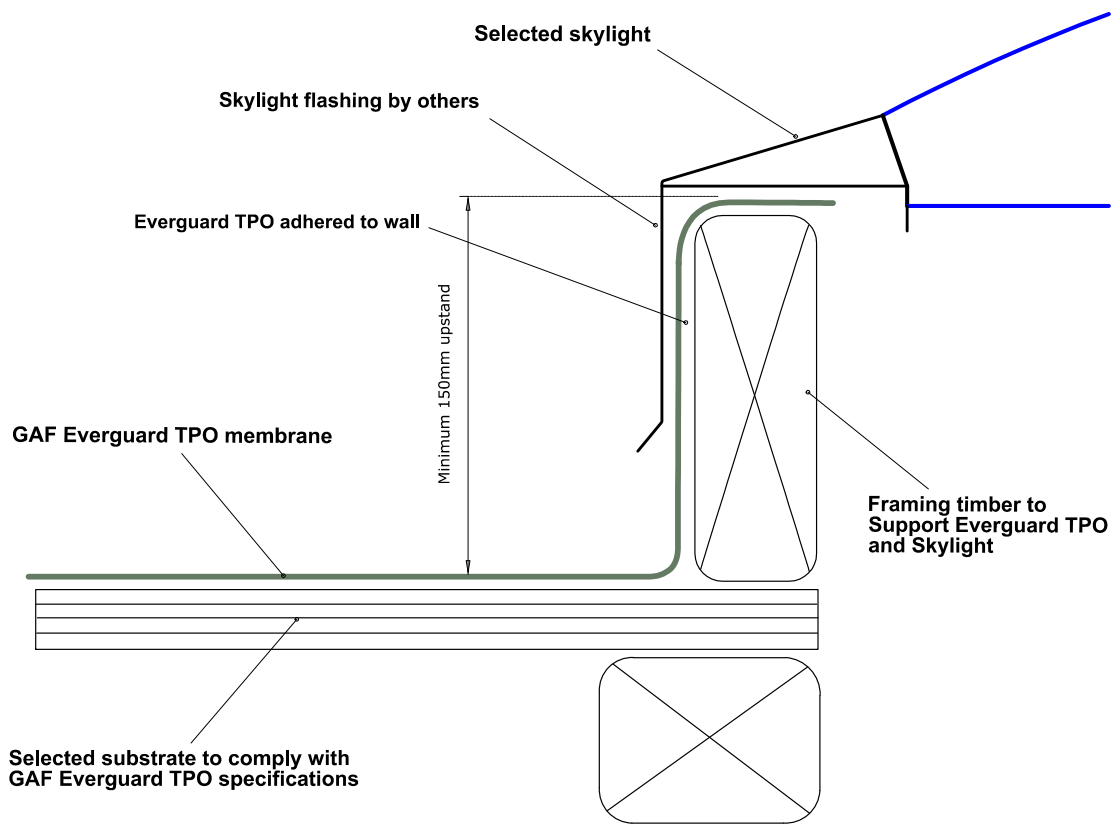

	DRAWING: <b>TRANSITION - WALL</b>	DATE: <b>10 JUNE 2014</b>	DETAIL: <b>203</b>	 BRANZ Appraised Appraisal No 529
	DETAILS FOR: <b>EVERGUARD TPO ROOFING</b>	SCALE: <b>N/A</b>		

CONSTRUCTION DETAILS FOR 'GAF TPO SINGLE-PLY ROOFING SYSTEM'





	DRAWING: <b>SKYLIGHT FLASHING</b>	DATE: <b>10 JUNE 2014</b>	DETAIL: <b>204</b>	 BRANZ Appraised Appraisal No 529
	DETAILS FOR: <b>EVERGUARD TPO ROOFING</b>	SCALE: <b>N/A</b>		



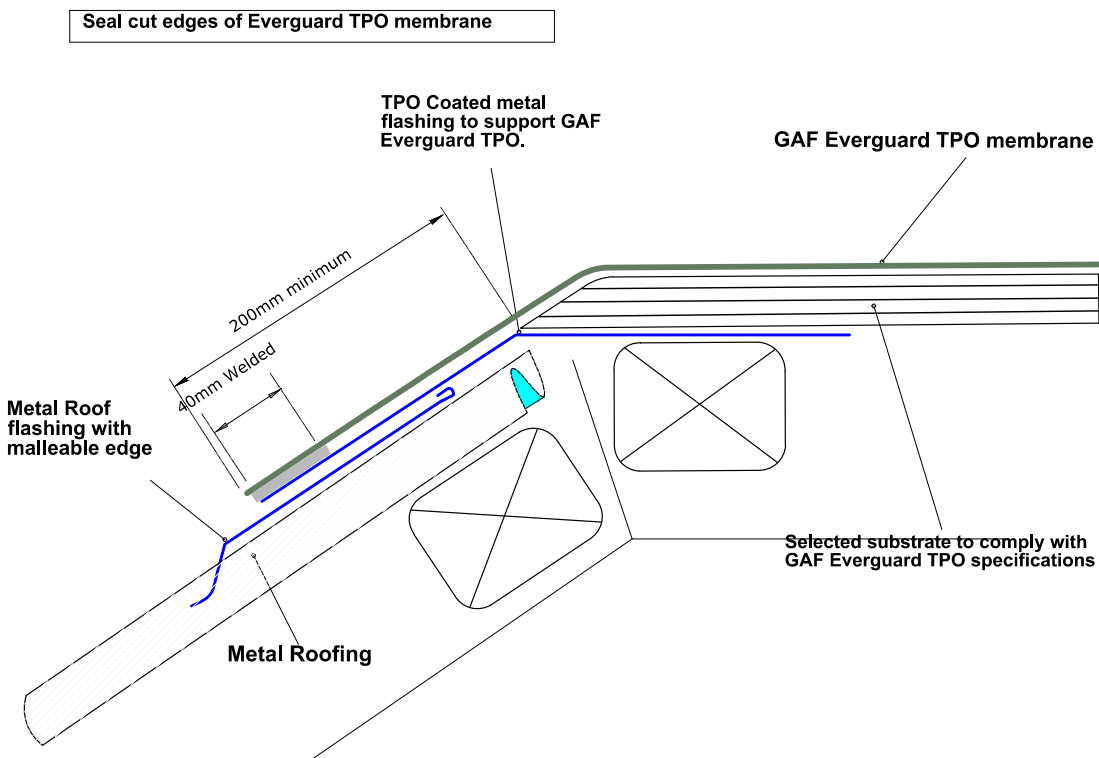

CONSTRUCTION DETAILS FOR 'GAF TPO SINGLE-PLY ROOFING SYSTEM'



	DRAWING: <b>TRANSITION - METAL ROOF</b>	DATE: <b>10 JUNE 2014</b>	DETAIL: <b>301</b>	 BRANZ Appraised Appraisal No 529
	DETAILS FOR: <b>EVERGUARD TPO ROOFING</b>	SCALE: <b>N/A</b>		

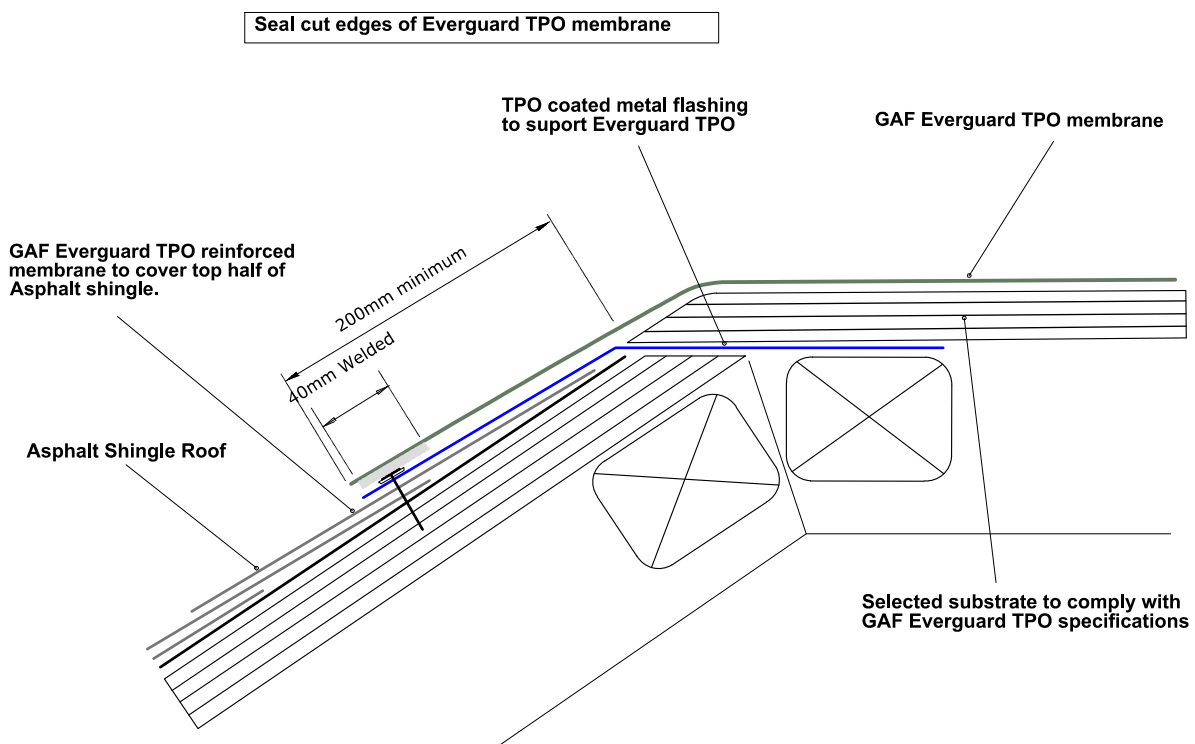

CONSTRUCTION DETAILS FOR 'GAF TPO SINGLE-PLY ROOFING SYSTEM'



	DRAWING: <b>TRANSITION - SHINGLE ROOF</b>	DATE: <b>10 JUNE 2014</b>	DETAIL: <b>302</b>	 BRANZ Appraised Appraisal No 529
	DETAILS FOR: <b>EVERGUARD TPO ROOFING</b>	SCALE: <b>N/A</b>		

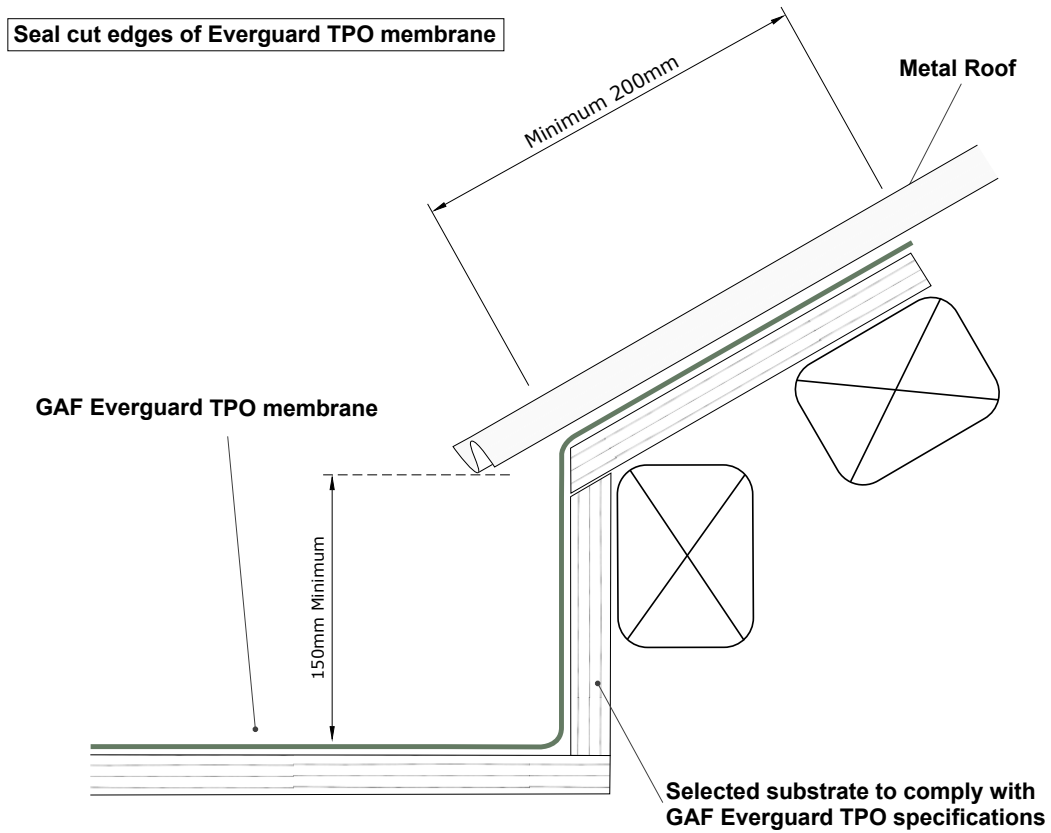

CONSTRUCTION DETAILS FOR 'GAF TPO SINGLE-PLY ROOFING SYSTEM'



	DRAWING: METAL ROOF TO TPO	DATE: 10 JUNE 2014	DETAIL: 303	 BRANZ Appraised Appraisal No 529
	DETAILS FOR: EVERGUARD TPO ROOFING	SCALE: N/A		

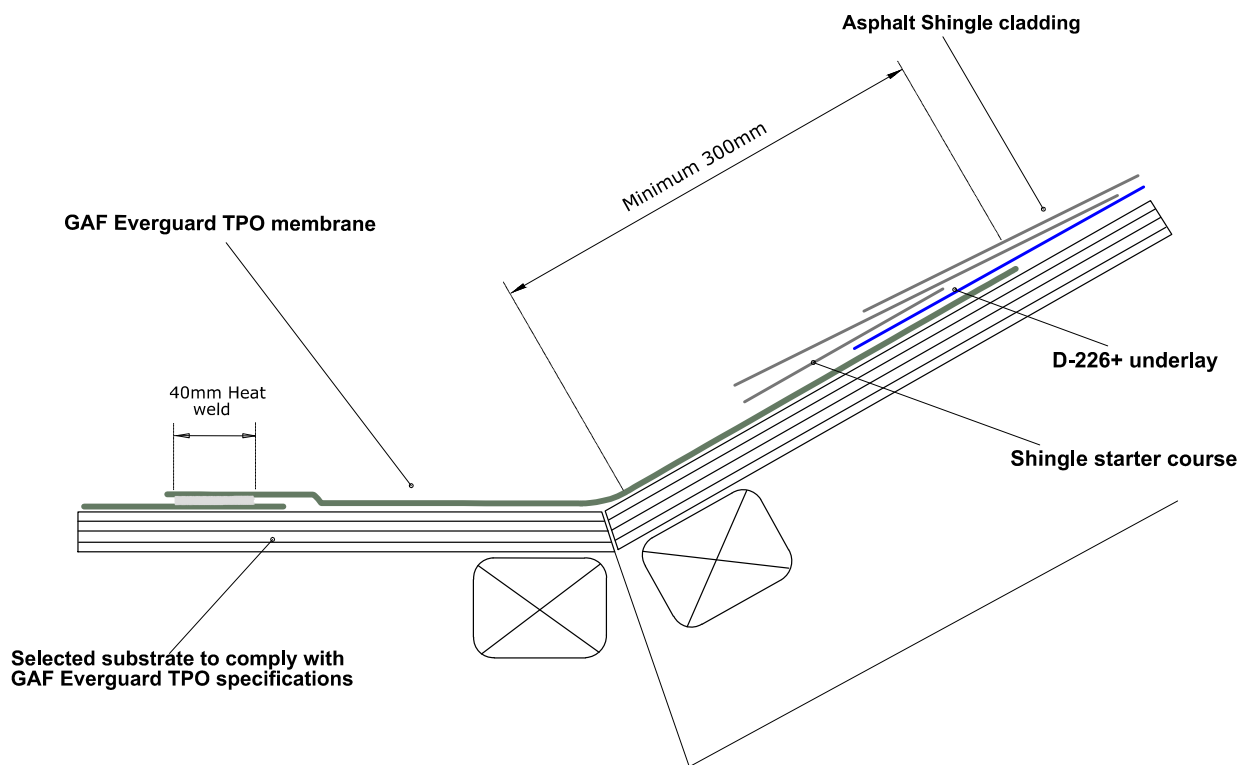

CONSTRUCTION DETAILS FOR 'GAF TPO SINGLE-PLY ROOFING SYSTEM'

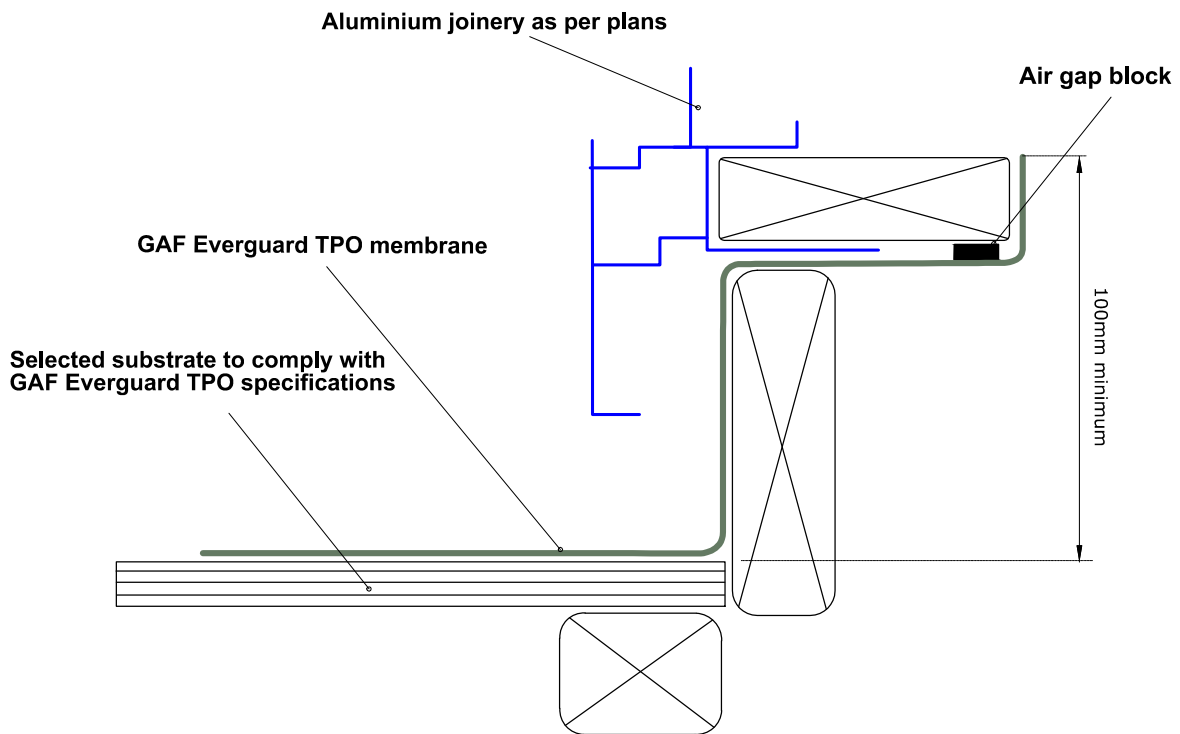

	DRAWING: <b>SHINGLE ROOF TO TPO</b>	DATE: <b>10 JUNE 2014</b>	DETAIL: <b>304</b>	 BRANZ Appraised Appraisal No 529
	DETAILS FOR: <b>EVERGUARD TPO ROOFING</b>	SCALE: <b>N/A</b>		

CONSTRUCTION DETAILS FOR 'GAF TPO SINGLE-PLY ROOFING SYSTEM'



	DRAWING: TPO TO ALUMINIUM JOINERY	DATE: 10 JUNE 2014	DETAIL: 305	 BRANZ Appraised Appraisal No 529
	DETAILS FOR: EVERGUARD TPO ROOFING	SCALE: N/A		

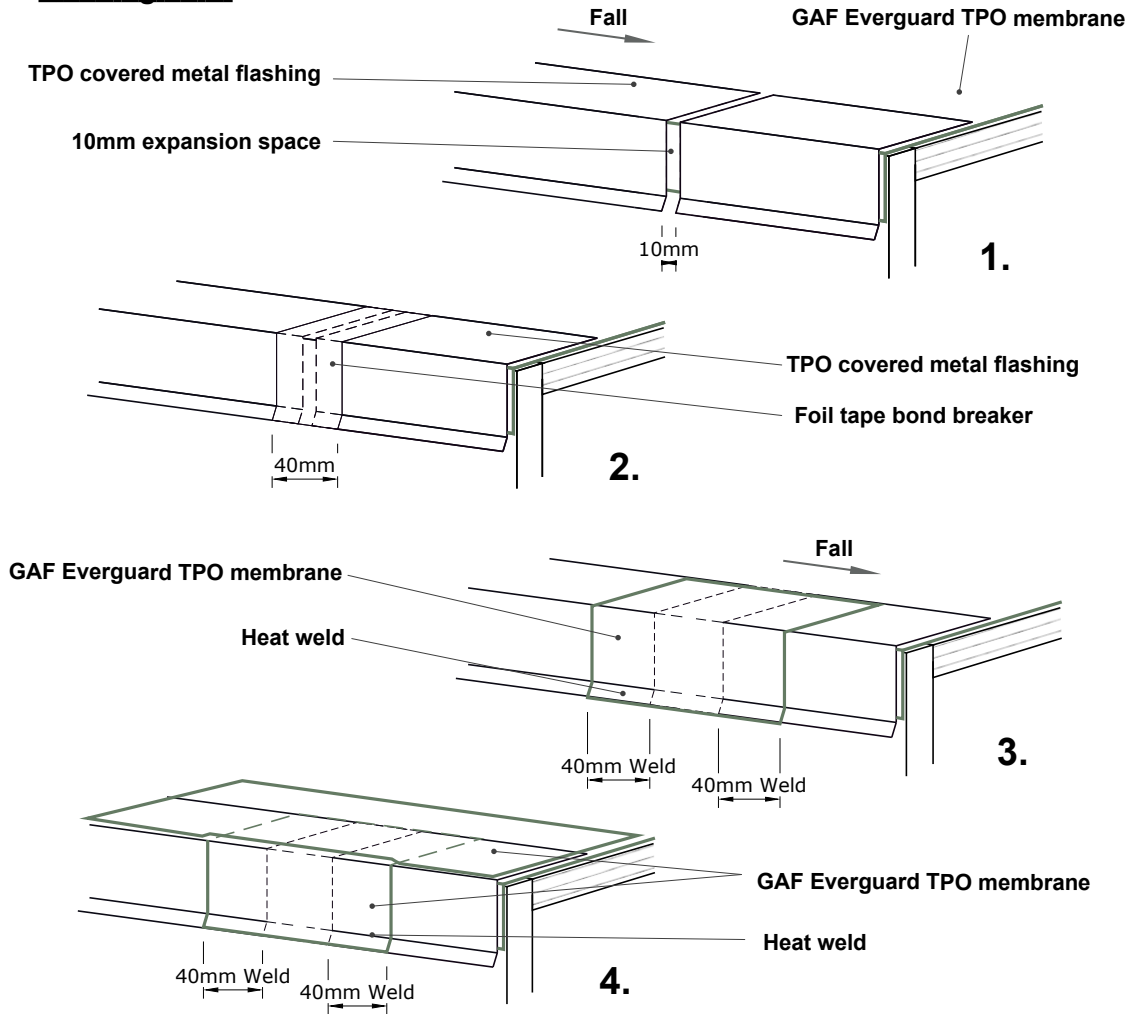

CONSTRUCTION DETAILS FOR 'GAF TPO SINGLE-PLY ROOFING SYSTEM'

**Flashing Joint**

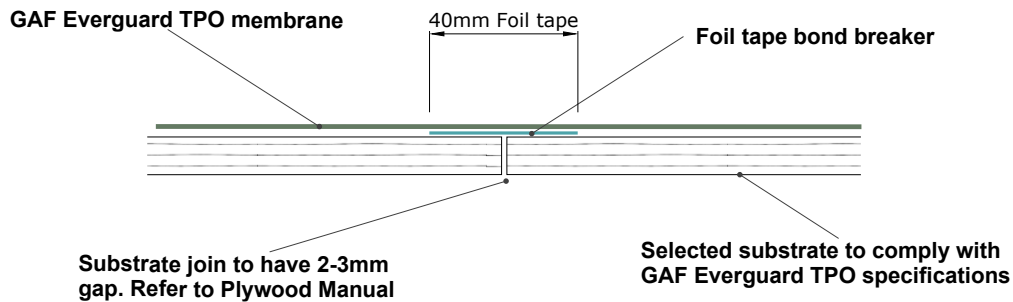

**Substrate Joint**





	DRAWING: <b>SUBSTRATE / FLASHING JOINT</b>	DATE: <b>10 JUNE 2014</b>	DETAIL: <b>306</b>	 BRANZ Appraised Appraisal No 529
	DETAILS FOR: <b>EVERGUARD TPO ROOFING</b>	SCALE: <b>N/A</b>		

CONSTRUCTION DETAILS FOR 'GAF TPO SINGLE-PLY ROOFING SYSTEM'

Seal cut edges of Everguard TPO membrane

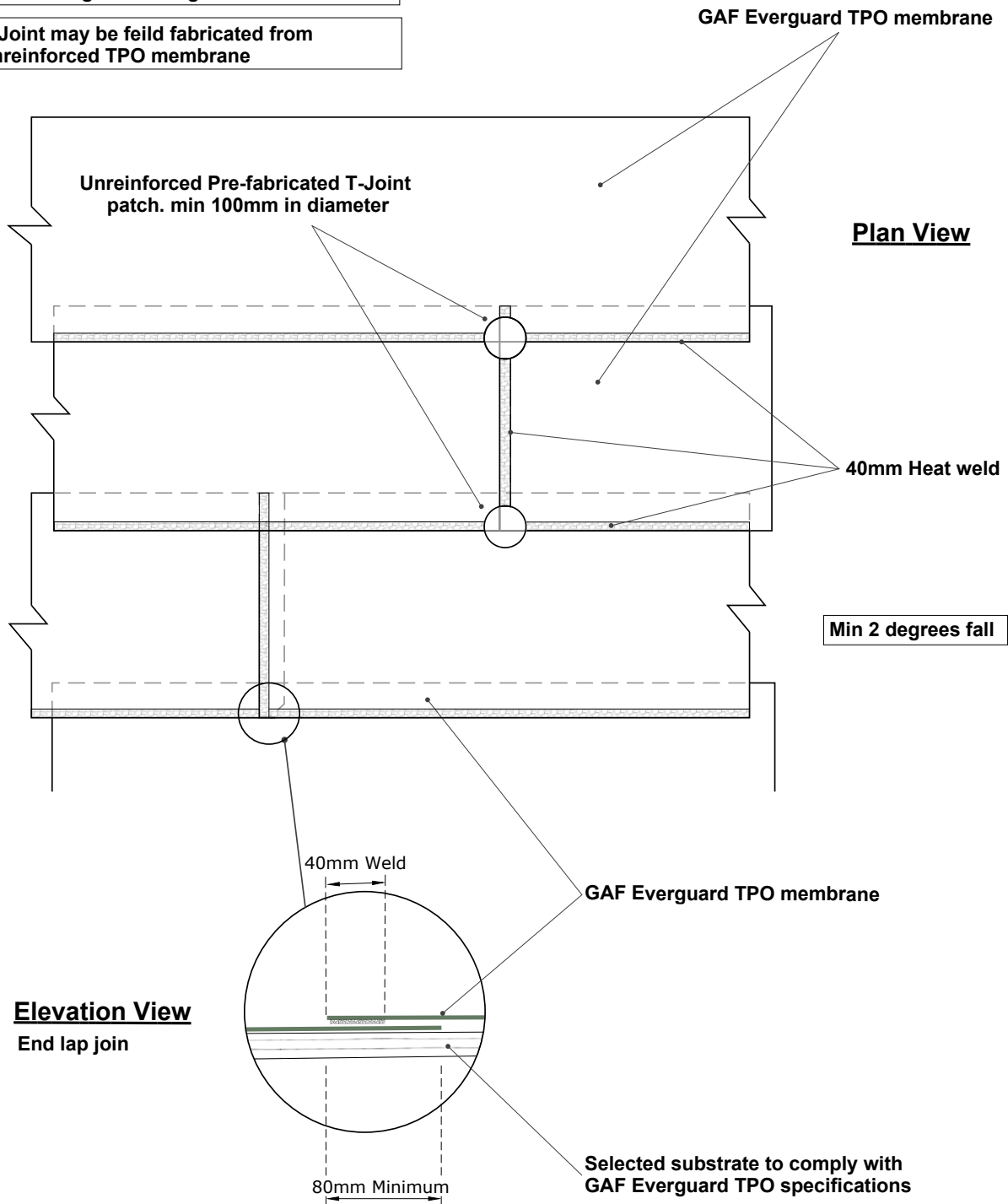
T-Joint may be feild fabricated from unreinforced TPO membrane





	DRAWING: T-JOINT / END JOINT DETAIL	DATE: 10 JUNE 2014	DETAIL: 401	 BRANZ Appraised Appraisal No 529
	DETAILS FOR: EVERGUARD TPO ROOFING	SCALE: N/A		

CONSTRUCTION DETAILS FOR 'GAF TPO SINGLE-PLY ROOFING SYSTEM'

Seal cut edges of Everguard TPO membrane

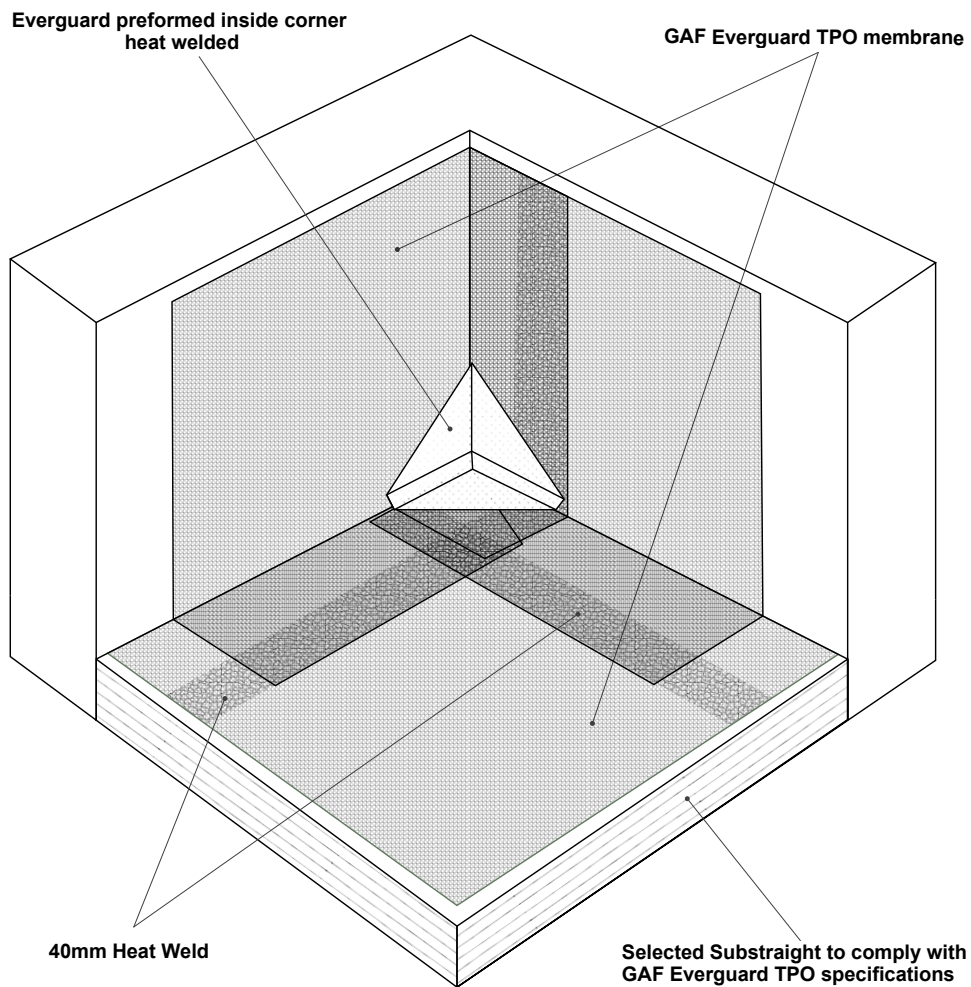
Min 2 degrees fall





	DRAWING: <b>PRE-FORMED INSIDE CORNER</b>	DATE: 10 JUNE 2014	DETAIL: 402	 BRANZ Appraised Appraisal No 529
	DETAILS FOR: <b>EVERGUARD TPO ROOFING</b>	SCALE: N/A		

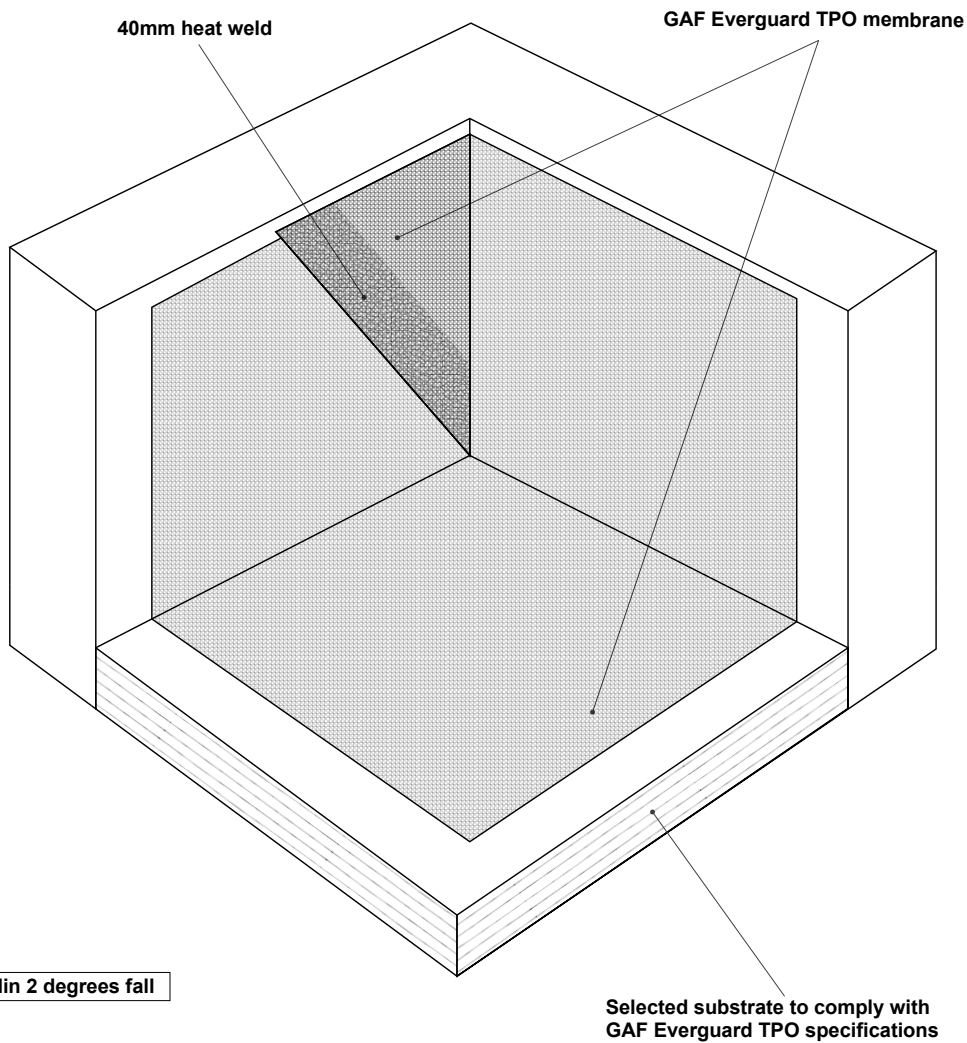

CONSTRUCTION DETAILS FOR 'GAF TPO SINGLE-PLY ROOFING SYSTEM'

Seal cut edges of Everguard TPO membrane





	DRAWING: FOLDED INSIDE CORNER	DATE: 10 JUNE 2014	DETAIL: 403	 BRANZ Appraised Appraisal No 529
	DETAILS FOR: EVERGUARD TPO ROOFING	SCALE: N/A		

CONSTRUCTION DETAILS FOR 'GAF TPO SINGLE-PLY ROOFING SYSTEM'

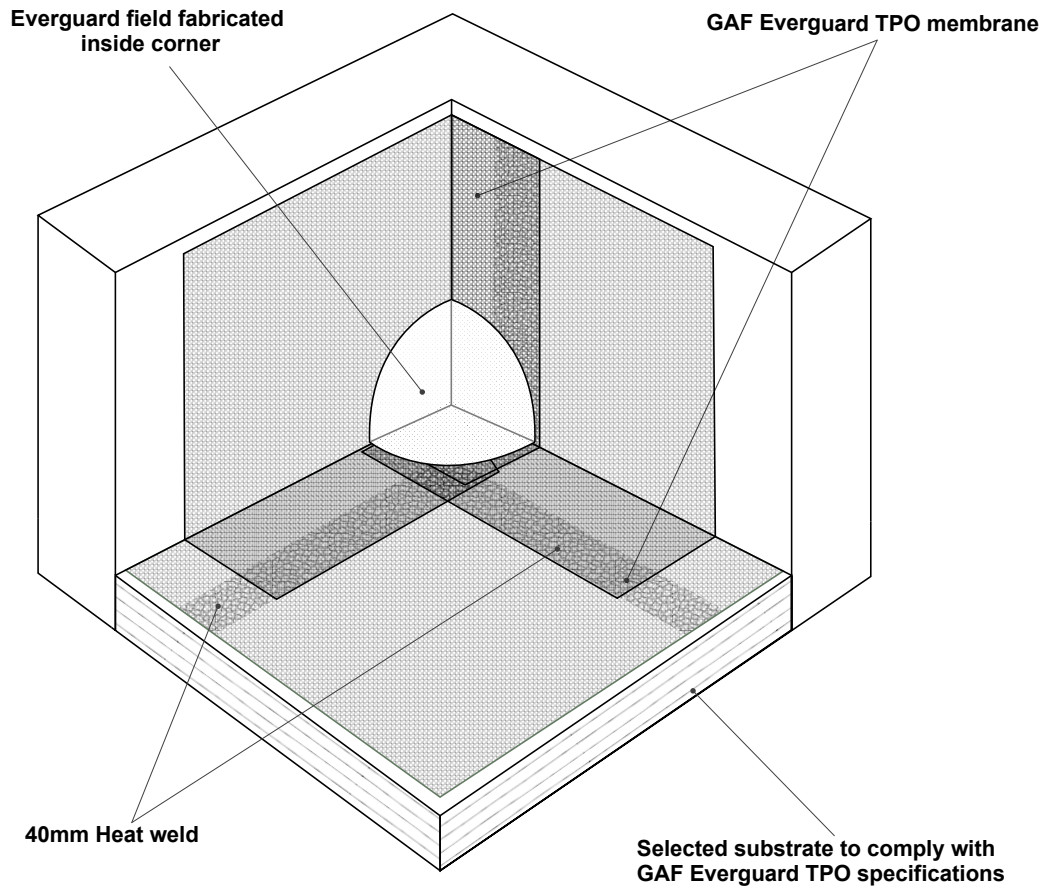
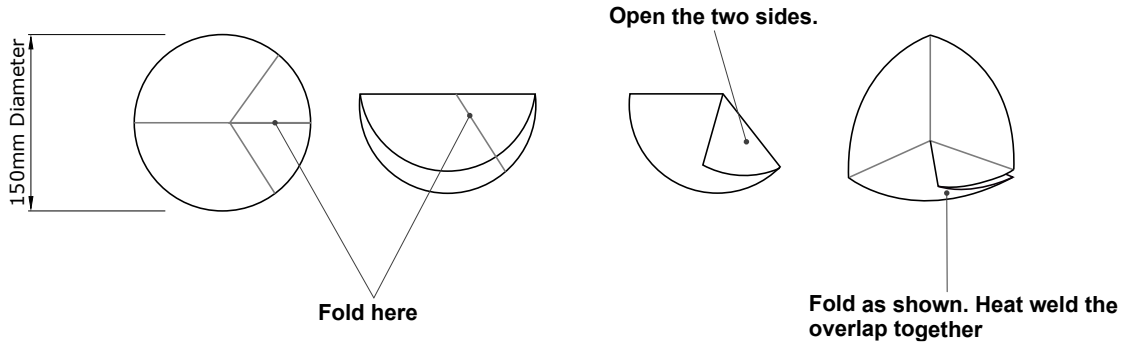
Everguard TPO field fabricated cut from non-reinforced membrane





	DRAWING: <b>FABRICATED INSIDE CORNER</b>	DATE: 10 JUNE 2014	DETAIL: 404	 BRANZ Appraised Appraisal No 529
	DETAILS FOR: <b>EVERGUARD TPO ROOFING</b>	SCALE: N/A		

CONSTRUCTION DETAILS FOR 'GAF TPO SINGLE-PLY ROOFING SYSTEM'

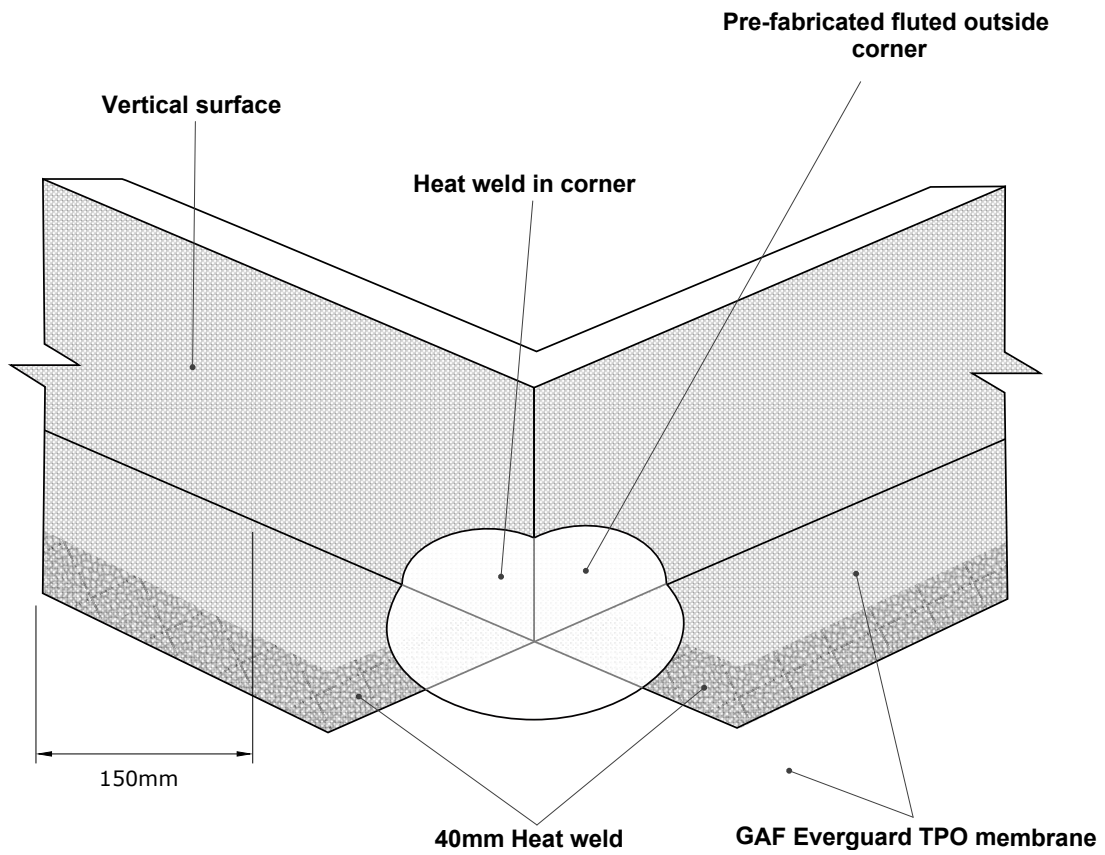
**Seal cut edges of Everguard TPO membrane**





	DRAWING: <b>FLUTED OUTSIDE CORNER</b>	DATE: <b>10 JUNE 2014</b>	DETAIL: <b>405</b>	 BRANZ Appraised Appraisal No 529
	DETAILS FOR: <b>EVERGUARD TPO ROOFING</b>	SCALE: <b>N/A</b>		

CONSTRUCTION DETAILS FOR 'GAF TPO SINGLE-PLY ROOFING SYSTEM'

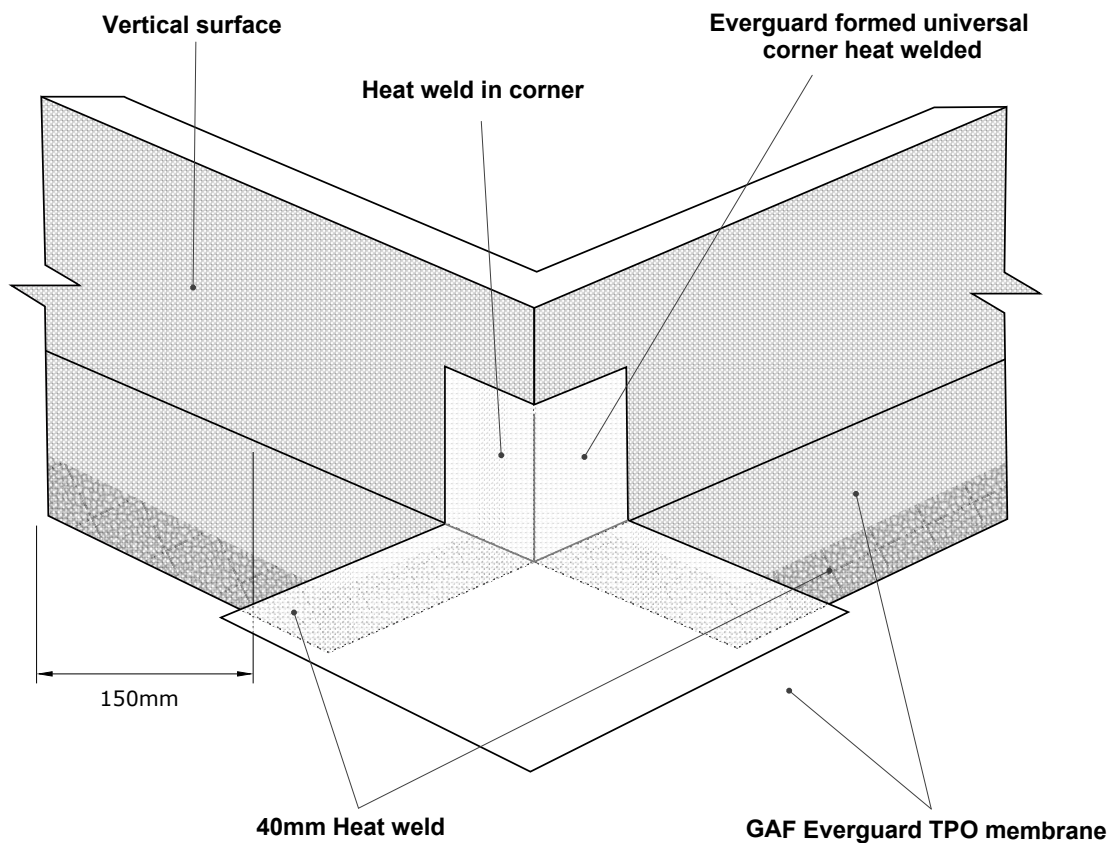
**Seal cut edges of Everguard TPO membrane**





	DRAWING: <b>WALL / CURB OUTSIDE CORNER</b>	DATE: <b>10 JUNE 2014</b>	DETAIL: <b>406</b>	 BRANZ Appraised Appraisal No 529
	DETAILS FOR: <b>EVERGUARD TPO ROOFING</b>	SCALE: <b>N/A</b>		

CONSTRUCTION DETAILS FOR 'GAF TPO SINGLE-PLY ROOFING SYSTEM'

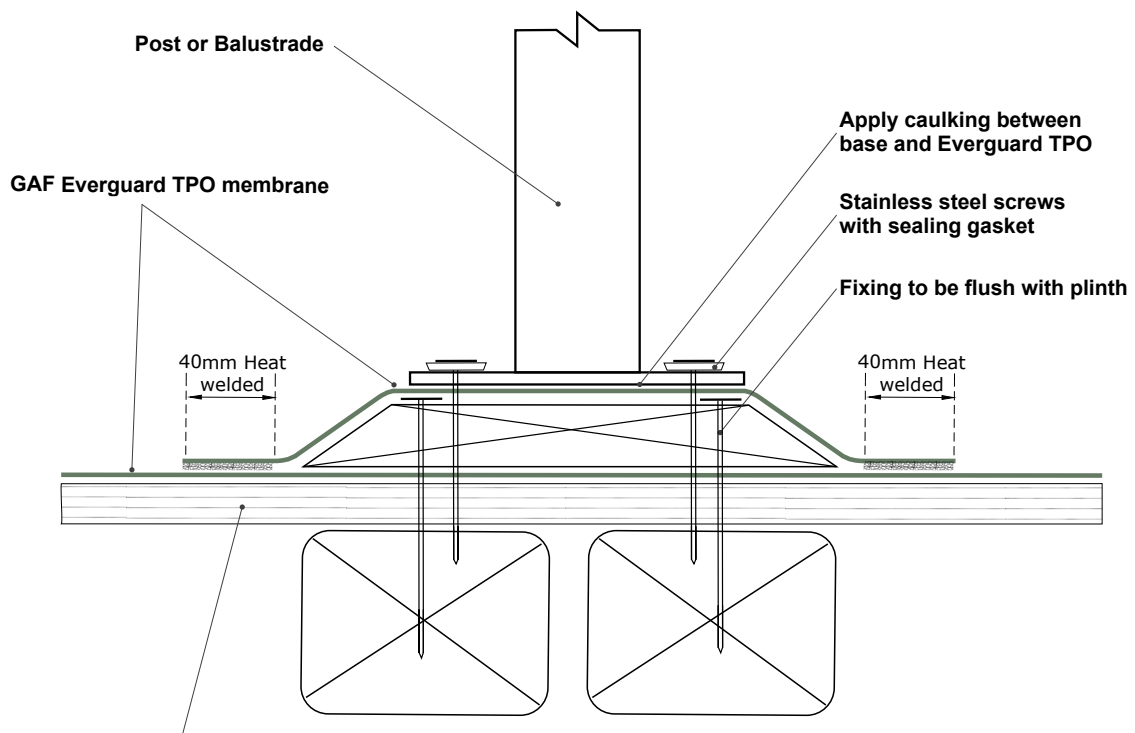
Seal cut edges of Everguard TPO membrane





	DRAWING: POST OR BALUSTRADE BASE	DATE: 10 JUNE 2014	DETAIL: 407	 BRANZ Appraised Appraisal No 529
	DETAILS FOR: EVERGUARD TPO ROOFING	SCALE: N/A		

CONSTRUCTION DETAILS FOR 'GAF TPO SINGLE-PLY ROOFING SYSTEM'

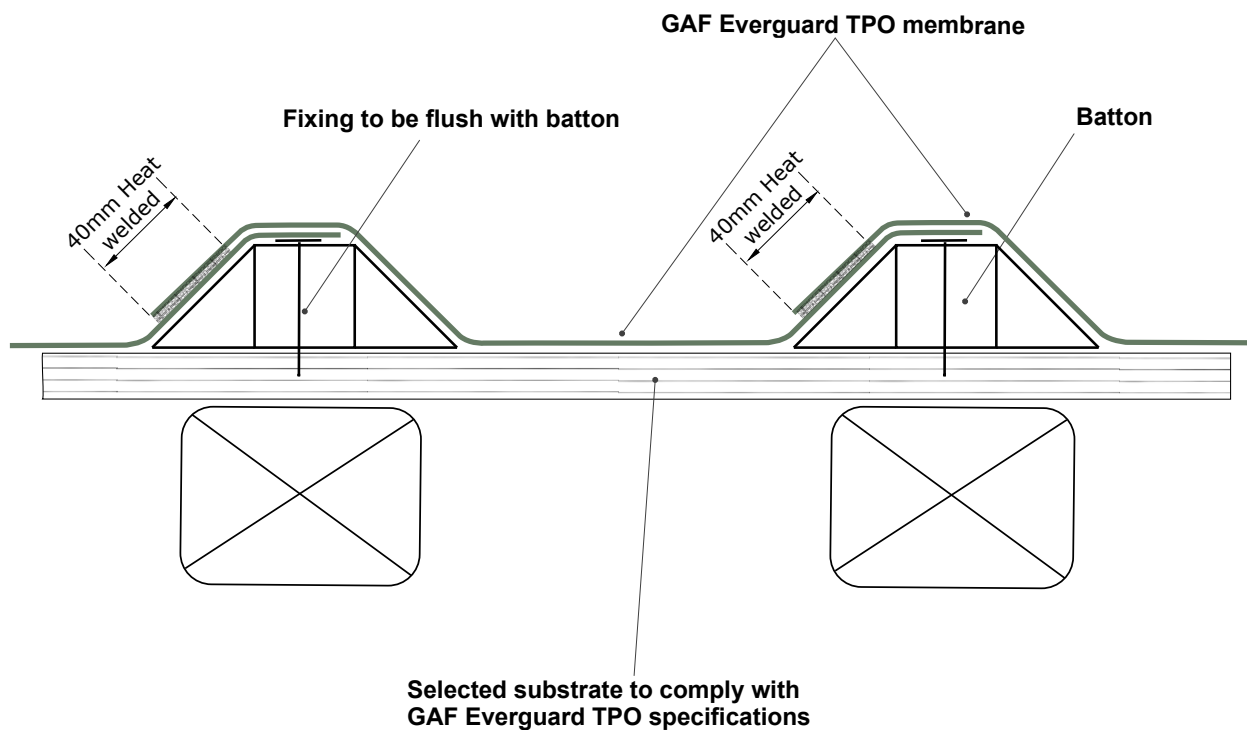
Seal cut edges of Everguard TPO membrane





	DRAWING: <b>DRESSED BATTEN</b>	DATE: <b>10 JUNE 2014</b>	DETAIL: <b>408</b>	 BRANZ Appraised Appraisal No 529
	DETAILS FOR: <b>EVERGUARD TPO ROOFING</b>	SCALE: <b>N/A</b>		

CONSTRUCTION DETAILS FOR 'GAF TPO SINGLE-PLY ROOFING SYSTEM'

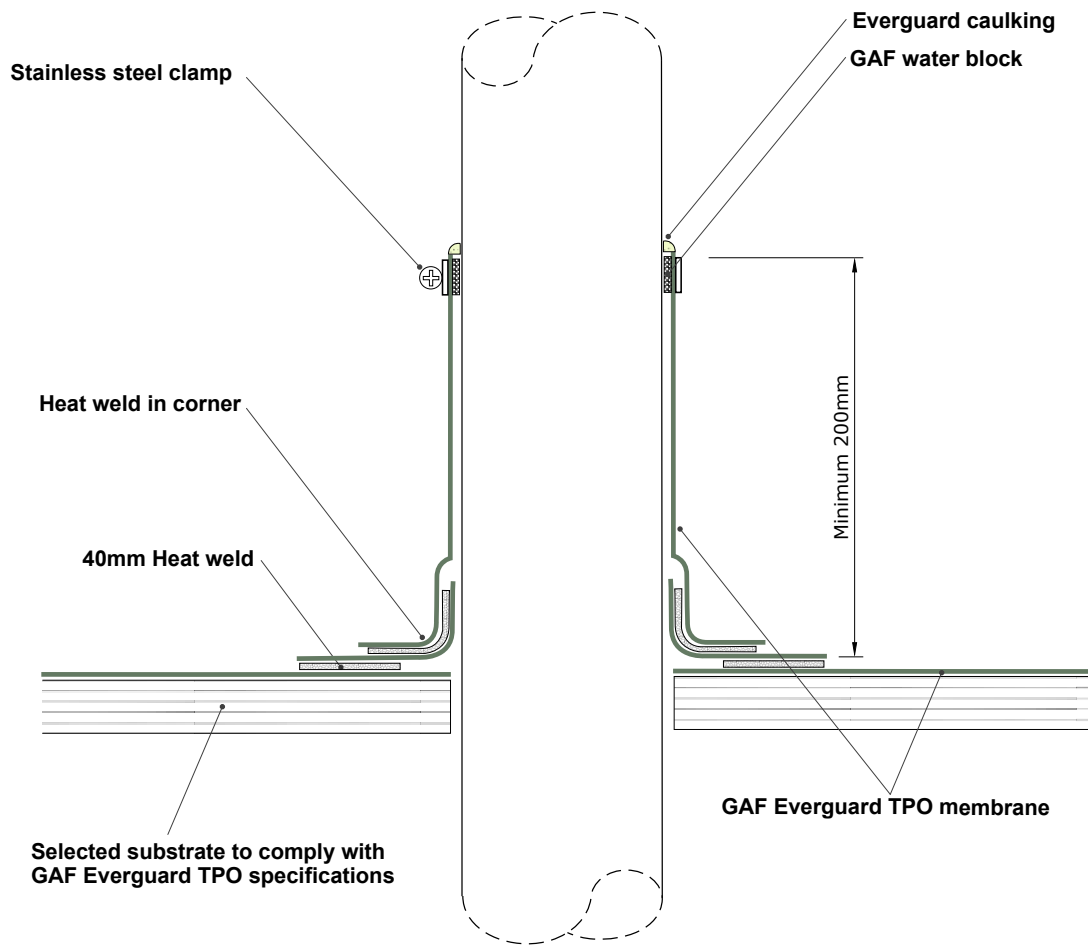
Seal cut edges of Everguard TPO membrane





	DRAWING: <b>PIPE PENETRATION</b>	DATE: <b>10 JUNE 2014</b>	DETAIL: <b>501</b>	 BRANZ Appraised Appraisal No 529
	DETAILS FOR: <b>EVERGUARD TPO ROOFING</b>	SCALE: <b>N/A</b>		

CONSTRUCTION DETAILS FOR 'GAF TPO SINGLE-PLY ROOFING SYSTEM'

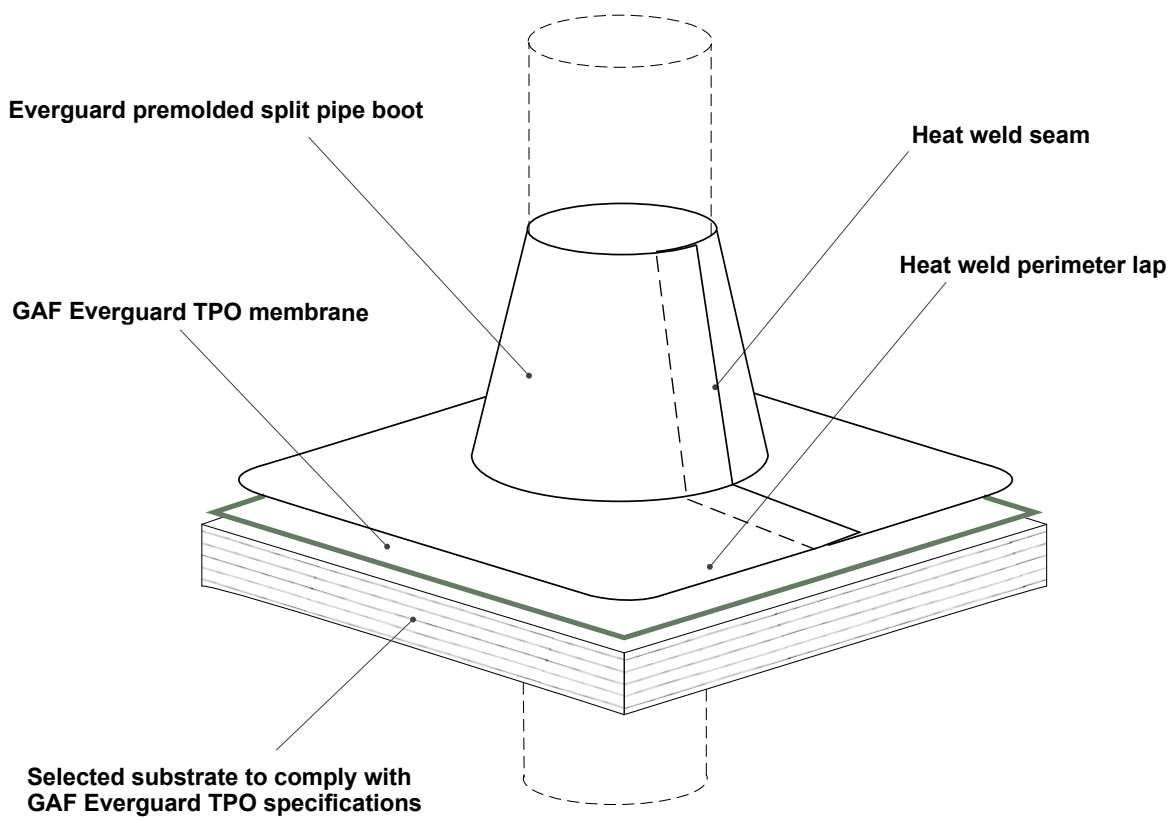
**Seal cut edges of Everguard TPO membrane**





	DRAWING: <b>SPLIT PIPE BOOT</b>	DATE: <b>10 JUNE 2014</b>	DETAIL: <b>502</b>	 BRANZ Appraised Appraisal No 529
	DETAILS FOR: <b>EVERGUARD TPO ROOFING</b>	SCALE: <b>N/A</b>		

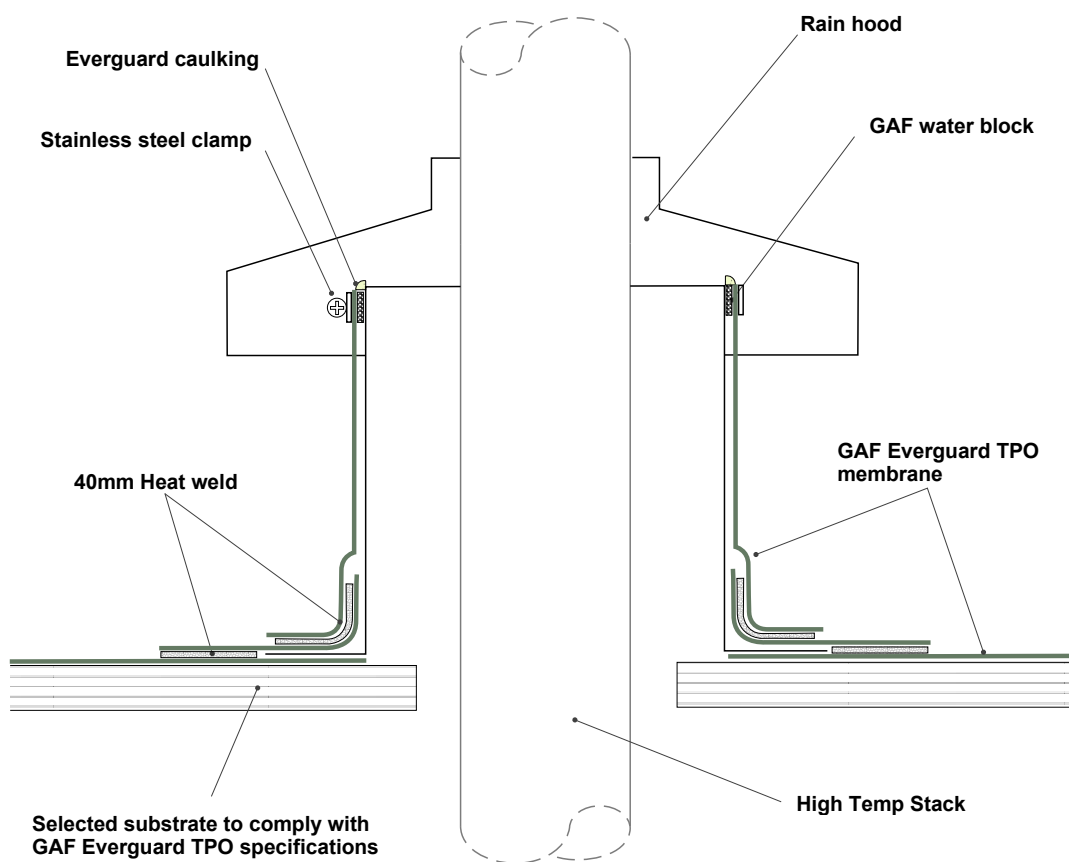

CONSTRUCTION DETAILS FOR 'GAF TPO SINGLE-PLY ROOFING SYSTEM'

Seal cut edges of Everguard TPO membrane





	DRAWING: <b>HIGH TEMP STACK FLASHING</b>	DATE: <b>10 JUNE 2014</b>	DETAIL: <b>503</b>	 BRANZ Appraised Appraisal No 529
	DETAILS FOR: <b>EVERGUARD TPO ROOFING</b>	SCALE: <b>N/A</b>		

CONSTRUCTION DETAILS FOR 'GAF TPO SINGLE-PLY ROOFING SYSTEM'

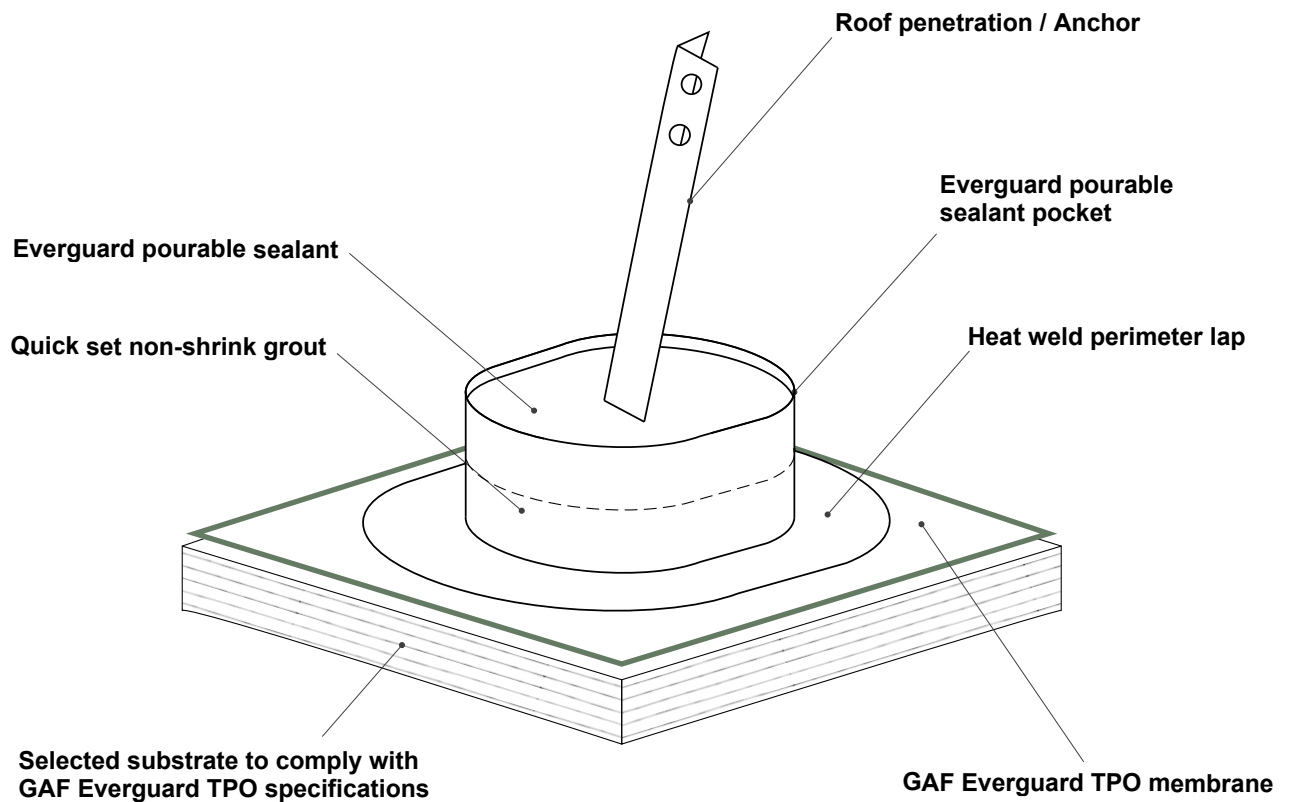
Seal cut edges of Everguard TPO membrane





	DRAWING: <b>POURABLE SEALANT POCKET</b>	DATE: <b>10 JUNE 2014</b>	DETAIL: <b>504</b>	 BRANZ Appraised Appraisal No 529
	DETAILS FOR: <b>EVERGUARD TPO ROOFING</b>	SCALE: <b>N/A</b>		

CONSTRUCTION DETAILS FOR 'GAF TPO SINGLE-PLY ROOFING SYSTEM'

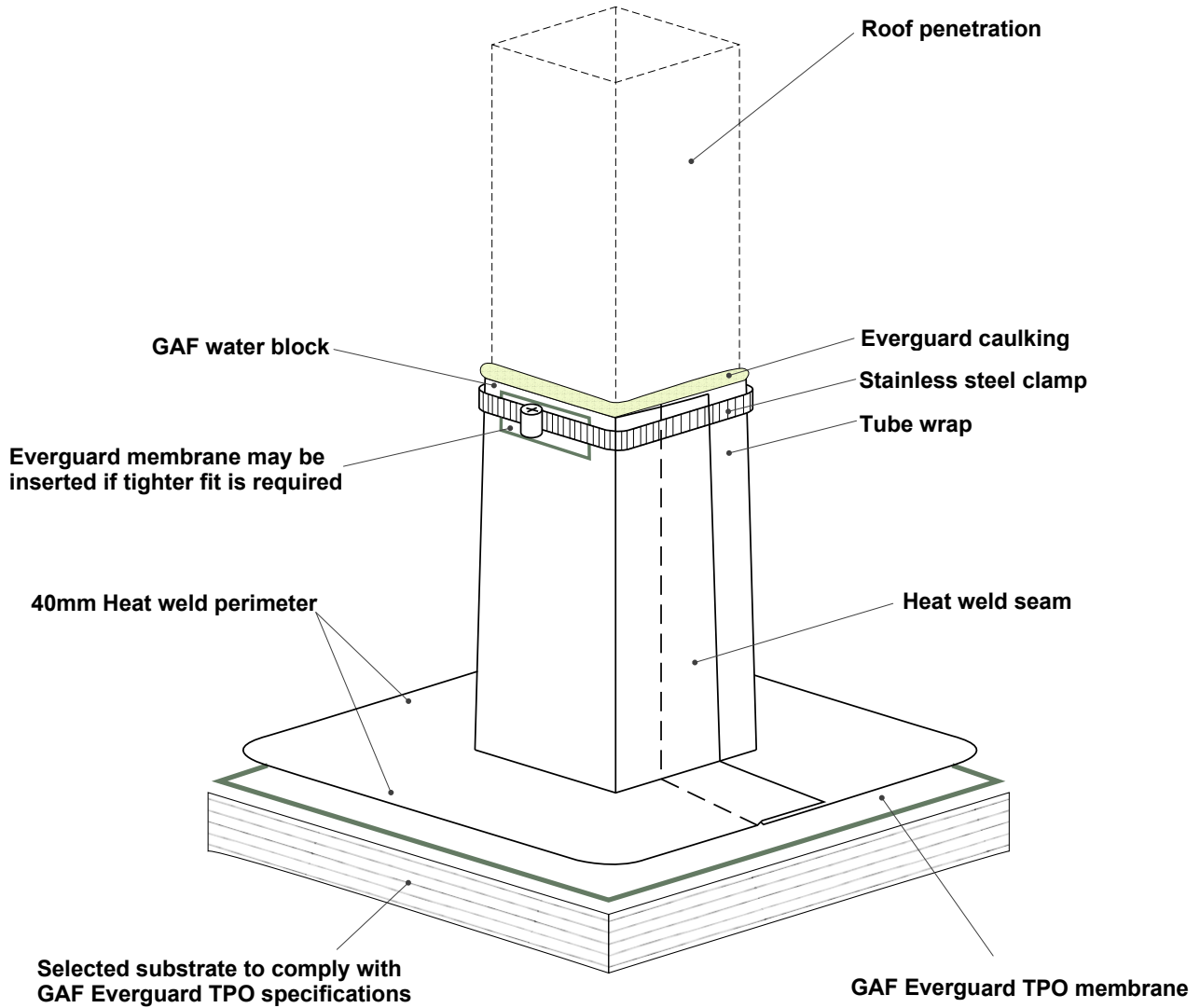
Seal cut edges of Everguard TPO membrane



	DRAWING: <b>SQUARE TUBE WRAP</b>	DATE: <b>10 JUNE 2014</b>	DETAIL: <b>505</b>	 BRANZ Appraised Appraisal No 529
	DETAILS FOR: <b>EVERGUARD TPO ROOFING</b>	SCALE: <b>N/A</b>		

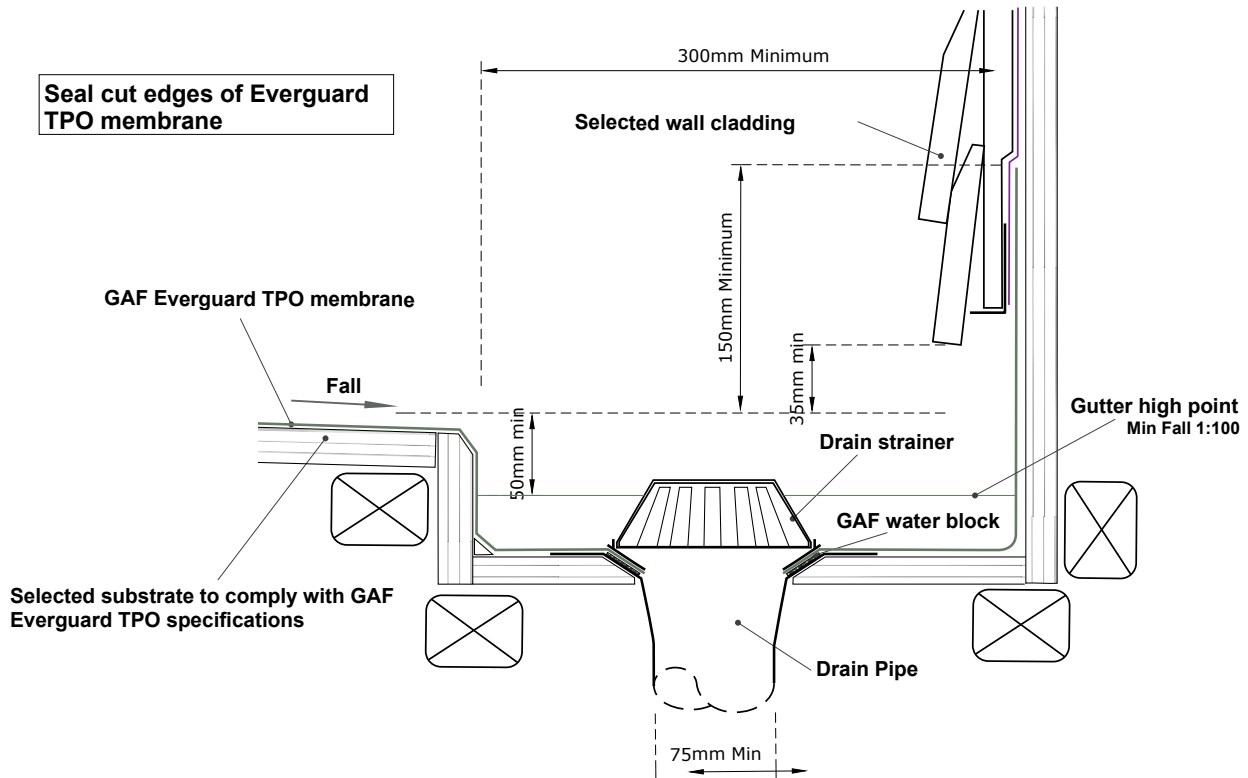

CONSTRUCTION DETAILS FOR 'GAF TPO SINGLE-PLY ROOFING SYSTEM'

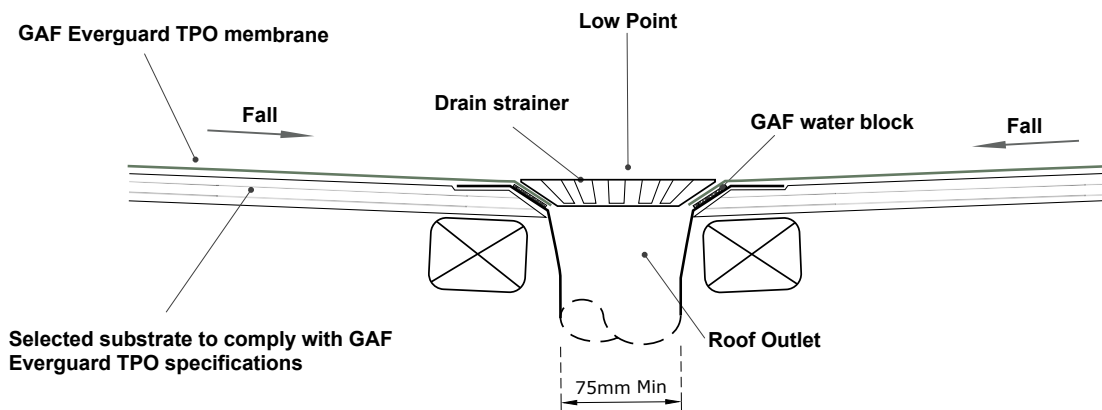

**Drain / Dropper**





**Low Point Outlet**

	DRAWING: <b>DRAIN / DROPPER</b>	DATE: <b>10 JUNE 2014</b>	DETAIL: <b>506</b>	 BRANZ Appraised Appraisal No 529
	DETAILS FOR: <b>EVERGUARD TPO ROOFING</b>	SCALE: <b>N/A</b>		

CONSTRUCTION DETAILS FOR 'GAF TPO SINGLE-PLY ROOFING SYSTEM'

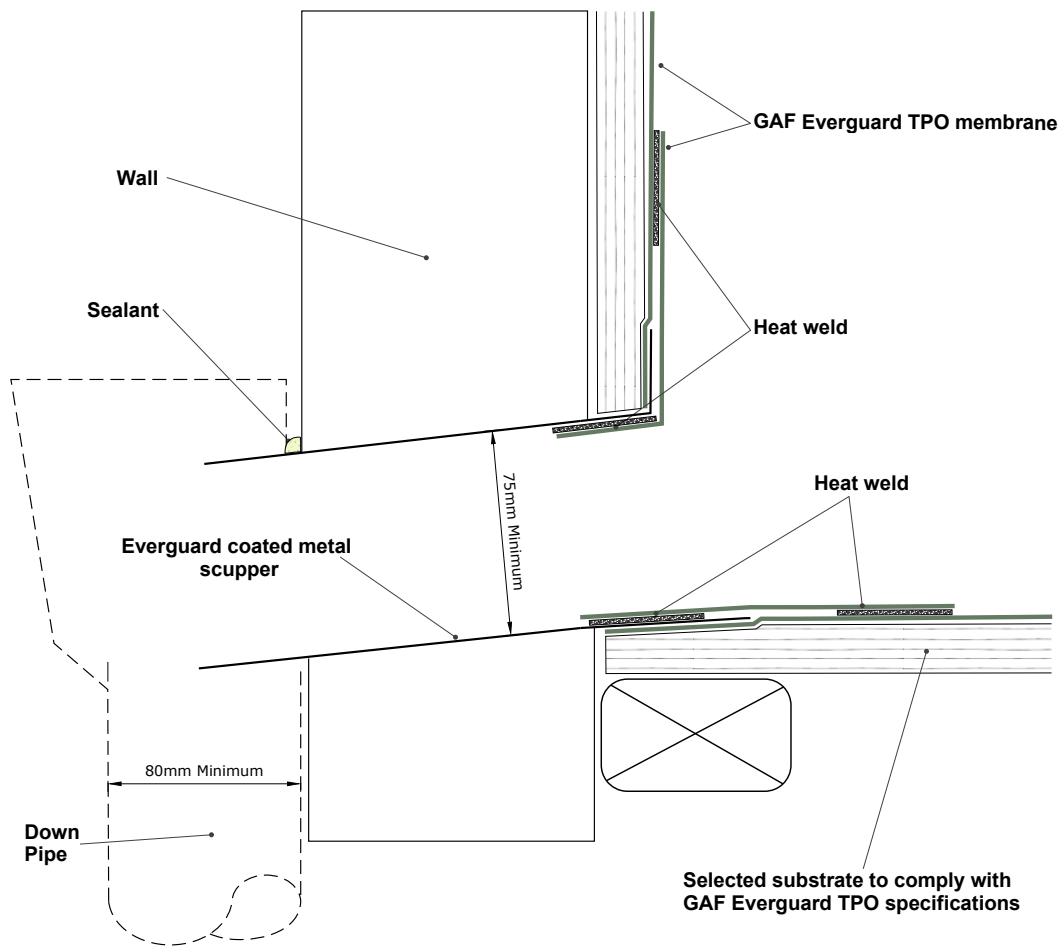
Seal cut edges of Everguard TPO membrane





	DRAWING: <b>COATED METAL SCRUPPER</b>	DATE: <b>10 JUNE 2014</b>	DETAIL: <b>507</b>	 BRANZ Appraised Appraisal No 529
	DETAILS FOR: <b>EVERGUARD TPO ROOFING</b>	SCALE: <b>N/A</b>		

CONSTRUCTION DETAILS FOR 'GAF TPO SINGLE-PLY ROOFING SYSTEM'

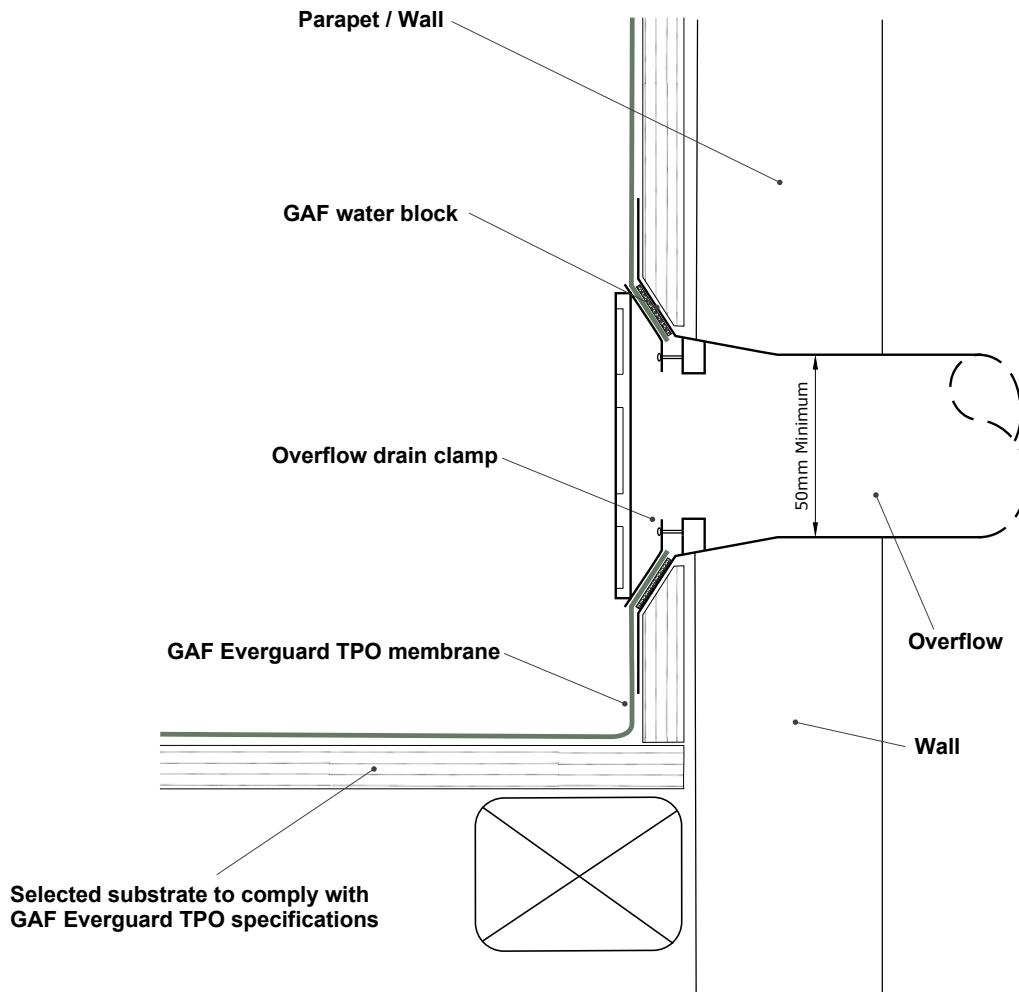

Seal cut edges of Everguard TPO membrane



	DRAWING: <b>OVERFLOW PARAPET DRAIN</b>	DATE: <b>10 JUNE 2014</b>	DETAIL: <b>508</b>	 BRANZ Appraised Appraisal No 529
	DETAILS FOR: <b>EVERGUARD TPO ROOFING</b>	SCALE: <b>N/A</b>		

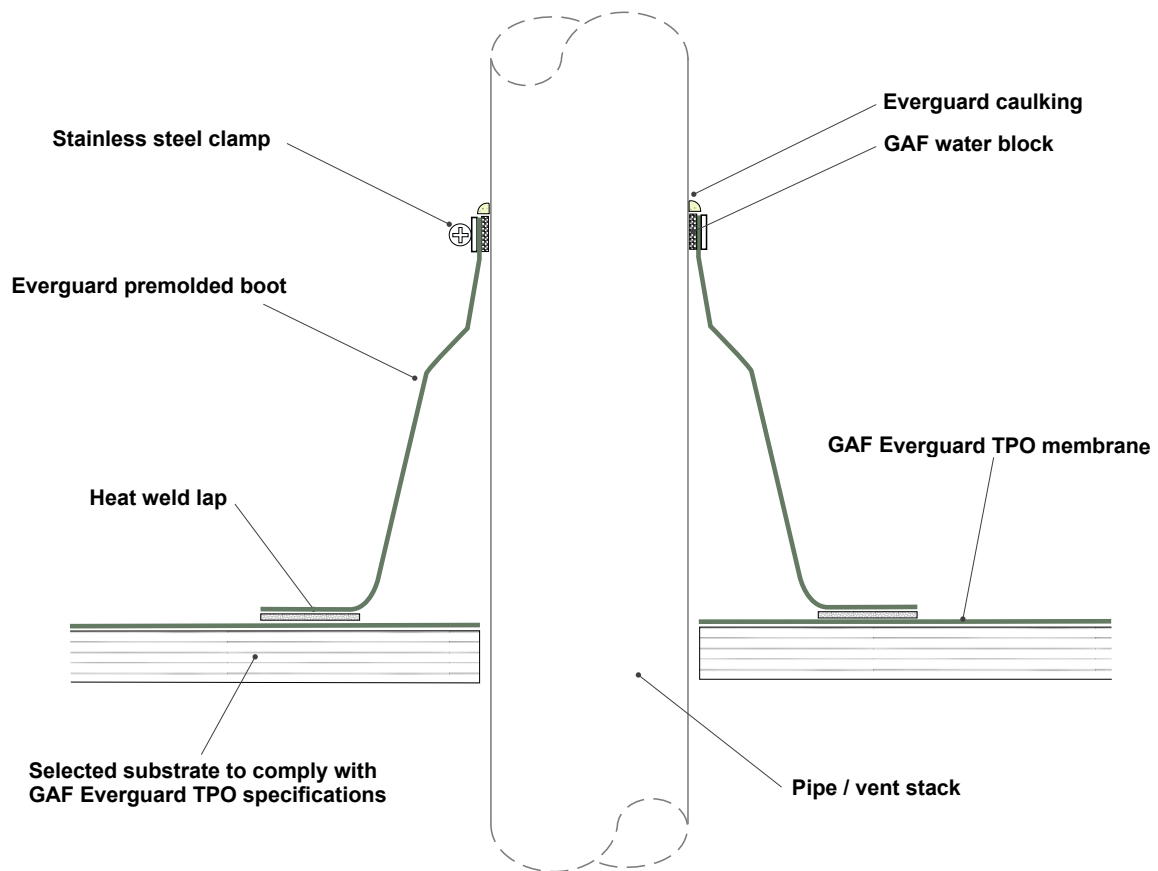

CONSTRUCTION DETAILS FOR 'GAF TPO SINGLE-PLY ROOFING SYSTEM'

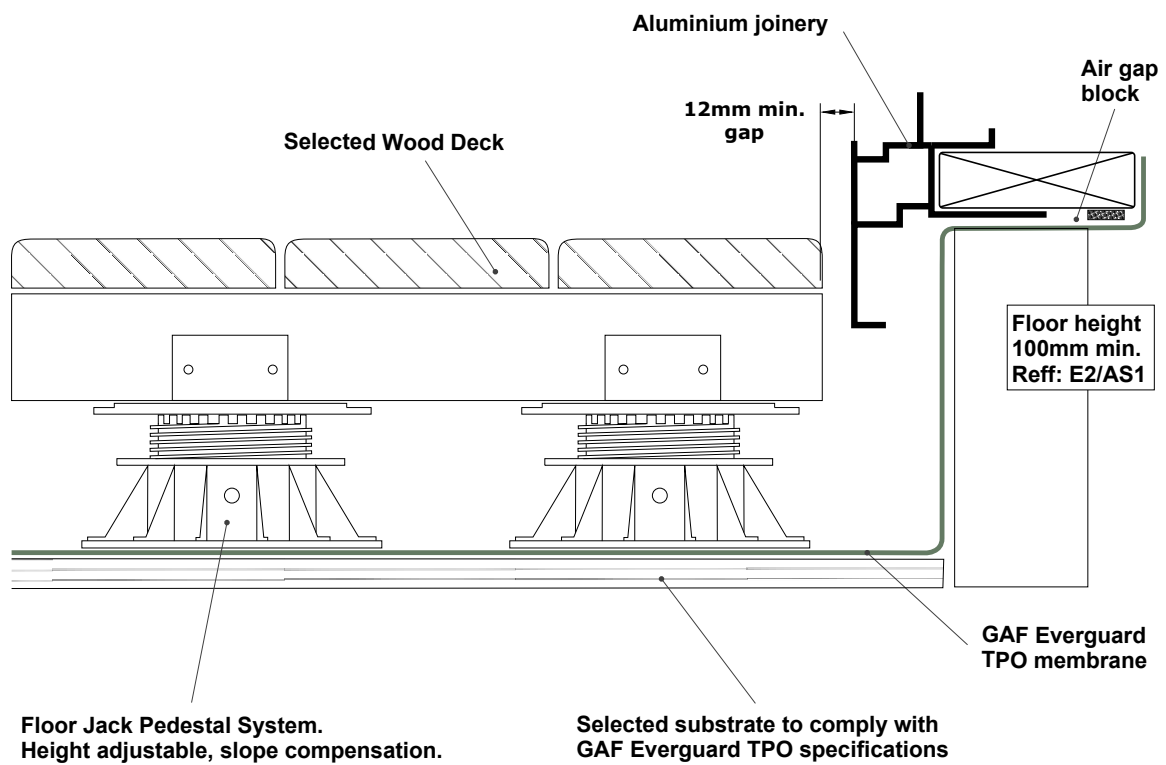

	DRAWING: <b>PREMOLDED PIPE BOOT</b>	DATE: <b>10 JUNE 2014</b>	DETAIL: <b>509</b>	 BRANZ Appraised Appraisal No 529
	DETAILS FOR: <b>EVERGUARD TPO ROOFING</b>	SCALE: <b>N/A</b>		

CONSTRUCTION DETAILS FOR 'GAF TPO SINGLE-PLY ROOFING SYSTEM'





	DRAWING: <b>FLOOR JACK PEDESTAL - DECK</b>	DATE: <b>10 JUNE 2014</b>	DETAIL: <b>601</b>	 BRANZ Appraised Appraisal No 529
	DETAILS FOR: <b>EVERGUARD TPO ROOFING</b>	SCALE: <b>N/A</b>		



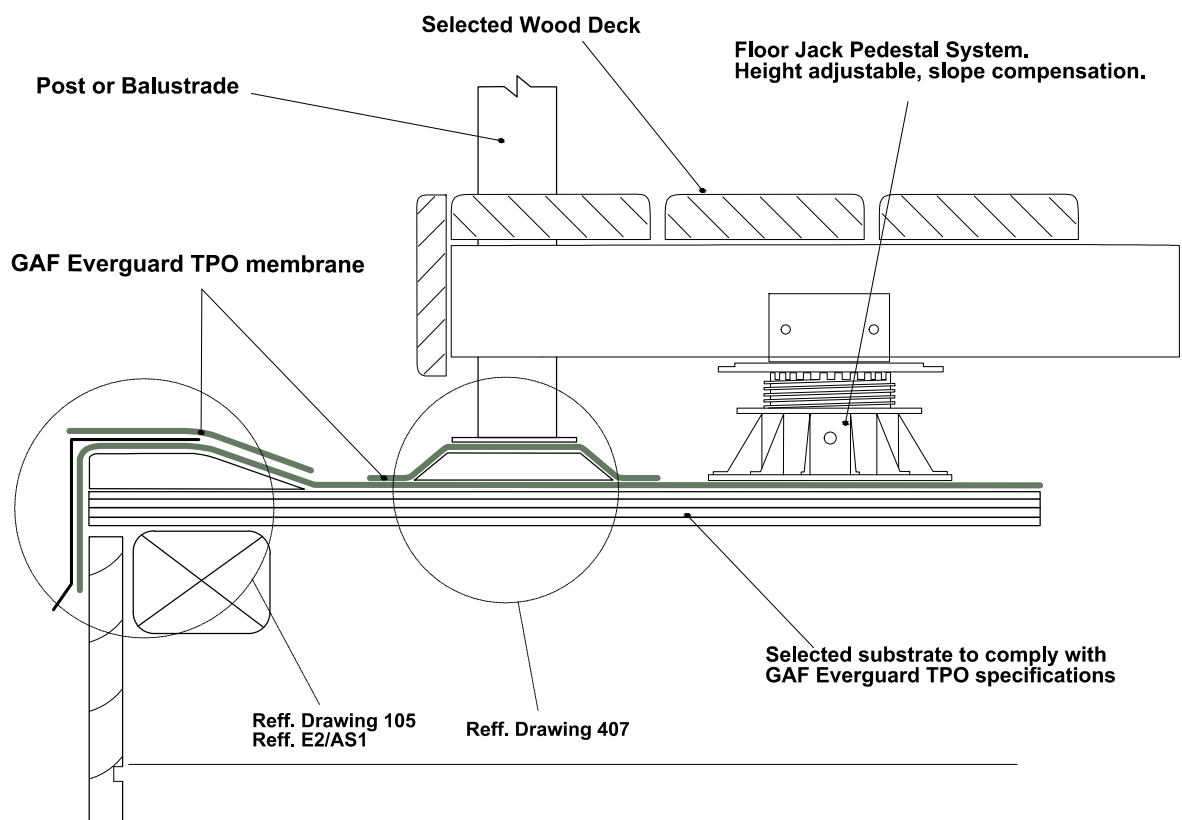

CONSTRUCTION DETAILS FOR 'GAF TPO SINGLE-PLY ROOFING SYSTEM'

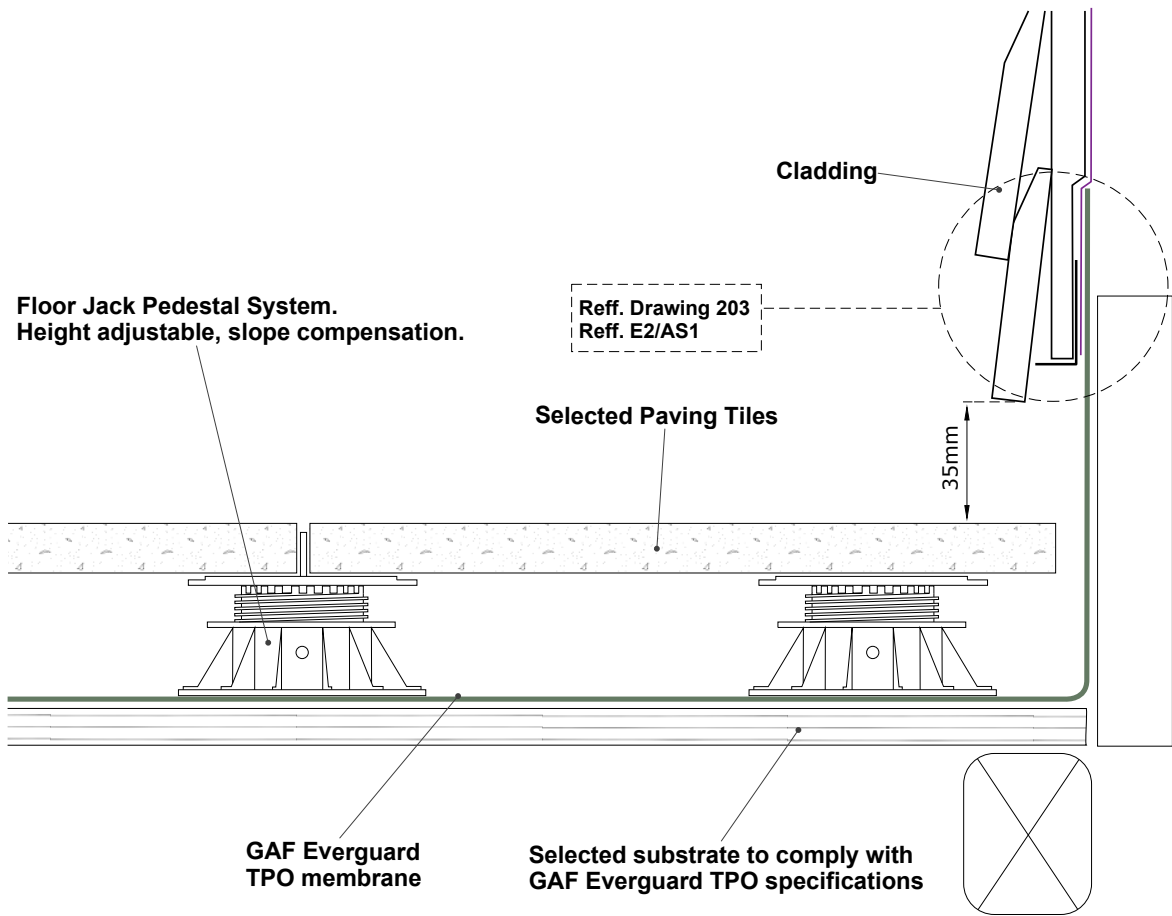

	DRAWING: <b>FLOOR JACK PEDESTAL - TERMINATION</b>	DATE: <b>10 JUNE 2014</b>	DETAIL: <b>602</b>	 BRANZ Appraised Appraisal No 529
	DETAILS FOR: <b>EVERGUARD TPO ROOFING</b>	SCALE: <b>N/A</b>		

CONSTRUCTION DETAILS FOR 'GAF TPO SINGLE-PLY ROOFING SYSTEM'



	DRAWING: FLOOR JACK PEDESTAL - PAVING TILES	DATE: 10 JUNE 2014	DETAIL: 603	 BRANZ Appraised Appraisal No 529
	DETAILS FOR: EVERGUARD TPO ROOFING	SCALE: N/A		

CONSTRUCTION DETAILS FOR 'GAF TPO SINGLE-PLY ROOFING SYSTEM'

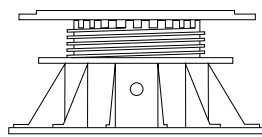
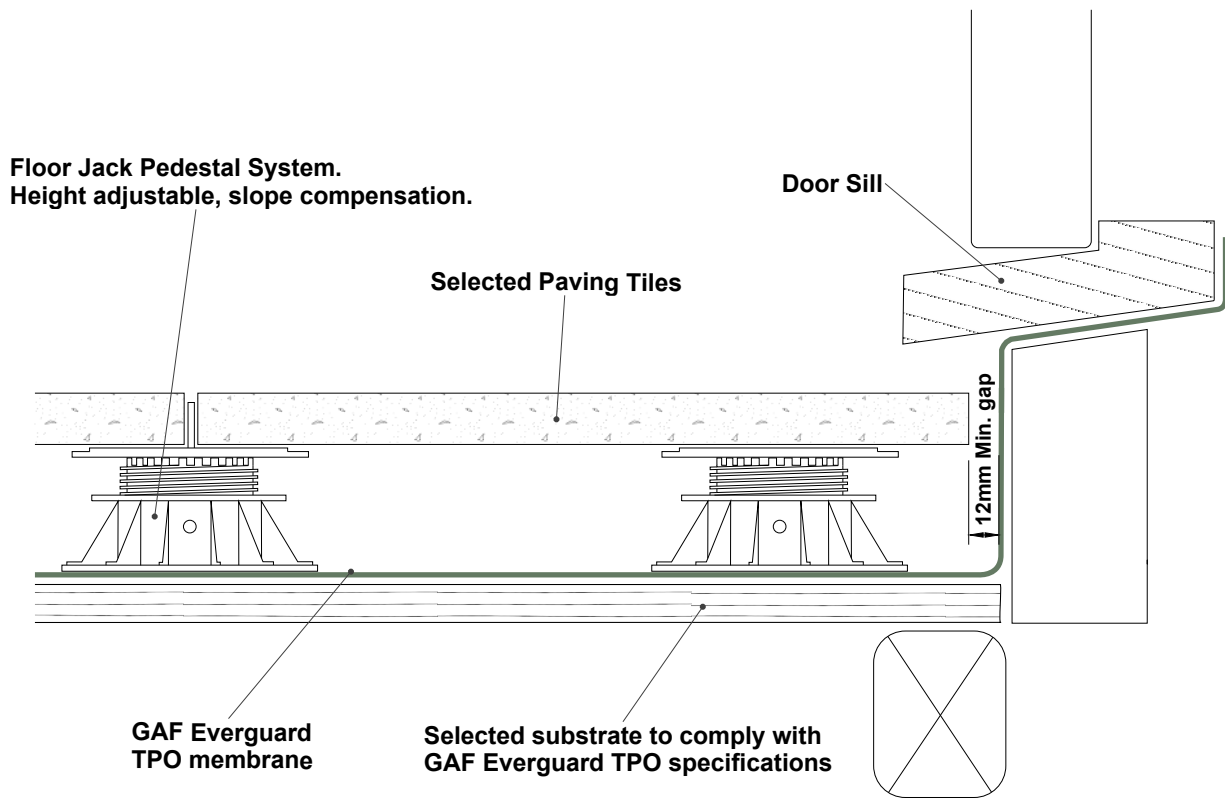

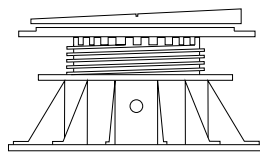

**Floor Jack Pedestal**

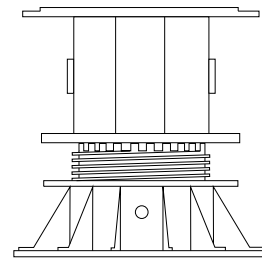

**Floor Jack Pedestal slope compensation.**



**Floor Jack Pedestal Height Extension.**

	DRAWING: <b>FLOOR JACK PEDESTAL - DOOR SILL</b>	DATE: <b>10 JUNE 2014</b>	DETAIL: <b>604</b>	 BRANZ Appraised Appraisal No 529
	DETAILS FOR: <b>EVERGUARD TPO ROOFING</b>	SCALE: <b>N/A</b>		